MANUAL

MODEL **1 2 4 3**
Generation 2

MultiMode™
MOTOR CONTROLLER

© 2002 CURTIS INSTRUMENTS, INC.

DESIGN OF CURTIS PMC 1200 SERIES
CONTROLLERS PROTECTED BY U.S.
PATENT NO. 4626750.

CURTIS

CURTIS INSTRUMENTS, INC.

200 Kisco Avenue
Mount Kisco, NY 10509 USA
Tel: 914-666-2971
Fax: 914-666-2188
www.curtisinst.com

1243eEN2 Manual, p/n 37044
Rev. A: October 2002

CONTENTS

1. OVERVIEW	1
2. INSTALLATION AND WIRING	4
Mounting the Controller	4
Connections: Low Current	6
Connections: High Current	6
Wiring: Controller	7
Wiring: Throttle	9
5k Ω -0, 2-wire potentiometer throttle (“Type 1”)	10
Single-ended 0–5V, current source, 3-wire pot, and electronic throttles (“Type 2”)	11
0–5k Ω , 2-wire potentiometer throttle (“Type 3”)	13
Wigwag 0–5V and 3-wire pot throttles	14
Wiring: Fault Outputs	14
Wiring: Spyglass Display	15
Wiring: Emergency Reverse	16
Wiring: Emergency Reverse Check	16
Wiring: Auxiliary Driver	16
Contactor, Switches, and Other Hardware	17
3. PROGRAMMABLE PARAMETERS	19
Battery Parameter	21
Battery Voltage	21
Acceleration Parameters	21
Drive Current Limit, M1–M4	21
Acceleration Rate, M1–M4	21
Quick Start	21
Current Ratio	22
Braking Parameters	23
Braking Current Limit, M1–M4	23
Deceleration Rate, M1–M4	23
Throttle Deceleration Rate	23
Restraint, M1–M4	23
Braking Rate, M1–M4	24
Taper Rate	25
Variable Braking	25
Interlock Braking Parameters	26
Interlock Braking Rate	26
Max. Forward Regen	26
Max. Reverse Regen	26

Min. Forward Regen 27

Min. Reverse Regen 27

Max. Load Volts 27

Min. Load Volts 27

Electromagnetic Brake Parameters 28

 Aux Type 28

 EM Brake PWM 28

 Aux Delay 28

 Interlock Brake Delay 28

Speed Parameters 31

 Max. Forward Speed, M1–M4 31

 Max. Reverse Speed, M1–M4 31

 Creep Speed 31

 Load Compensation 31

Throttle Parameters 32

 Throttle Type 32

 Throttle Deadband 32

 Throttle Max 34

 Throttle Map 36

 Pot Low Fault 38

Field Parameters 38

 Min. Field Current Limit 38

 Max. Field Current Limit 38

 Field Map Start 38

 Field Map 39

 Field Check 40

Main Contactor Parameters 40

 Main Contactor Interlock 40

 Main Contactor Open Delay 40

 Main Contactor Diagnostics 40

Sequencing Fault Parameters 41

 Anti-Tiedown 41

 High Pedal Disable (HPD) 41

 Static Return to Off (SRO) 42

 Sequencing Delay 42

Emergency Reverse Parameters 43

 Emergency Reverse Current Limit 43

 Emergency Reverse Check 43

 Emergency Reverse Direction Interlock 43

Motor Protection Parameters 44

 Warm Speed 44

 Motor Warm Resistance 44

 Motor Hot Resistance 44

 Motor Resistance Compensation 44

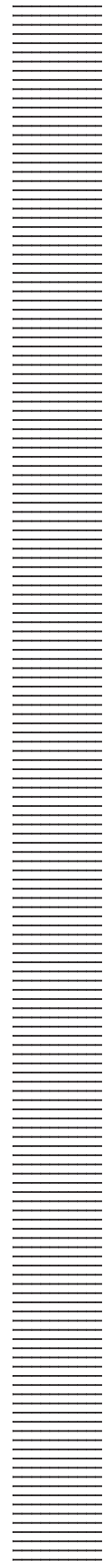

Hourmeter Parameters	45	
Adjust Hours High	45	
Adjust Hours Middle	45	
Adjust Hours Low	45	
Set Total Hours	45	
Set Traction Hours	46	
Total Service Hours	46	
Traction Service Hours	46	
Total Disable Hours	46	
Traction Disable Hours	46	
Traction Fault Speed	47	
Service Total	47	
Service Traction	47	
Hourmeter Type	48	
Pump Meter	48	
Battery Discharge Indicator (BDI) Parameters	49	
Full Voltage	49	
Empty Voltage	49	
Reset Voltage	49	
Battery Adjust	50	
BDI Disable	50	
BDI Limit Speed	50	
Fault Code Parameters	51	
Fault Code	51	
BDI Lockout	51	
Controller Cloning	52	
4. INSTALLATION CHECKOUT	53	
5. VEHICLE PERFORMANCE ADJUSTMENT	55	
Major Tuning	55	
Tuning the active throttle range	55	
Tuning the controller to the motor	58	
Setting the unloaded vehicle top speed	60	
Equalizing loaded and unloaded vehicle speed	61	
Fine Tuning	62	
Response to reduced throttle	62	
Response to increased throttle	63	
Smoothness of direction transitions	63	
Ramp climbing	64	

6. PROGRAMMER MENUS	65	
1243GEN2 Program Menu	65	
1243GEN2 Monitor Menu.....	69	
1243GEN2 System Faults Menu.....	70	
7. DIAGNOSTICS AND TROUBLESHOOTING	71	
Programmer Diagnostics	71	
Spyglass Diagnostics	71	
Status LED Diagnostics	74	
Fault Output LED Diagnostics.....	75	
8. CONTROLLER MAINTENANCE	76	
Cleaning	76	
Diagnostic History	76	
APPENDIX A Electromagnetic Compatibility (EMC)	A-1	
APPENDIX B 1311 Programmer Operation	B-1	
APPENDIX C Programmable Parameters Index	C-1	
APPENDIX D Specifications	D-1	

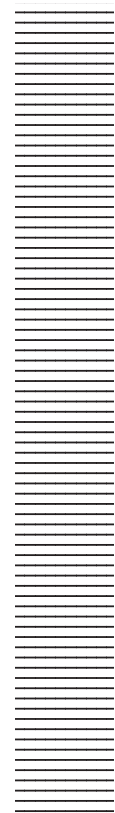

FIGURES

FIG. 1:	Curtis 1243GEN2 electronic motor controller	1
FIG. 2:	Mounting dimensions, Curtis 1243GEN2 controller	4
FIG. 3:	Basic wiring configuration, Curtis 1243GEN2 controller	7
FIG. 4:	Wiring for 5k Ω -0 throttle (“Type 1”)	10
FIG. 5:	Wiring for 20k Ω potentiometer used as a wigwag-style throttle (“Type 1”)	10
FIG. 6:	Wiring for 0-5V throttles (“Type 2”)	11
FIG. 7:	Wiring for current source throttle (“Type 2”)	12
FIG. 8:	Wiring for 3-wire potentiometer throttle (“Type 2”)	12
FIG. 9:	Wiring for Curtis ET-XXX electronic throttle (“Type 2”)	13
FIG. 10:	Wiring for 0-5k Ω throttle (“Type 3”)	14
FIG. 11:	Wiring for fault outputs	15
FIG. 12:	Wiring for Curtis Spyglass display	15
FIG. 13:	Ramp restraint maps for controller with the minimum field set at 3 amps, maximum field at 18 amps, and braking current limit at 300 amps	24
FIG. 14:	Electromagnetic brake parameters, in the context of the four delay parameters	29
FIG. 15:	Effect of adjusting the throttle deadband parameter	33
FIG. 16:	Effect of adjusting the throttle max parameter	34, 35
FIG. 17:	Throttle maps for controller with maximum speed set at 100% and creep speed set at 0	36
FIG. 18:	Throttle maps for controller with maximum speed set at 100% and creep speed set at 10%	37

FIG. 19: Throttle maps for controller
with maximum speed set at 90%
and creep speed set at 10% 37

FIG. 20: Field current relative to armature current,
with field map parameter set at 50% and 20% 39

FIG. 21: Curtis 840 Spyglass, 3-LED and 6-LED models 73

FIG. B-1 Curtis 1311 handheld programmer B-1

TABLES

TABLE 1: Throttle wiper input (Pin 6) threshold values 9

TABLE 2: Mode selection 18

TABLE 3: Configuration options: auxiliary driver 30

TABLE 4: Programmable throttle types 32

TABLE 5: Standard battery voltages 49

TABLE 6: Fault categories 50

TABLE 7: Troubleshooting chart 72

TABLE 8: Status LED fault codes 74

TABLE 9: Fault category codes 75

TABLE D-1: Specifications E-1

1

OVERVIEW

Curtis 1243 Generation 2 MultiMode™ controllers are separately excited motor speed controllers designed for use in a variety of small industrial vehicles and in material handling equipment. These programmable controllers are simple to install, efficient, and cost effective, while offering more features than the original 1243.

Fig. 1 *Curtis 1243GEN2 MultiMode™ electronic motor controller.*



The 1243GEN2 MultiMode™ controller provides smooth precise control of motor speed and torque. A full-bridge field control stage is combined with a half-bridge armature power stage to provide solid state motor reversing and full regenerative braking without additional relays or contactors.

The controller's rugged IP53 housing and packaging are built to withstand shock and vibration. State-of-the-art surface mount logic board fabrication makes the 1243GEN2 controller even more reliable than the original 1243.

The 1243GEN2 is fully programmable through the Curtis 13XX handheld programmer. In addition to configuration flexibility, the programmer provides diagnostic and test capability.

Like all Curtis motor controllers, the 1243^{GEN2} offers superior operator control of the vehicle's motor drive speed. **Features include:**

- ✓ Interlock braking with load sensor to meet required braking distance without unnecessary harsh braking at light loads
- ✓ Maintenance monitor responds to preset vehicle operating hours and drive hours as programmed by the OEM
- ✓ Two hourmeters—total KSI-on hours and traction hours—and the associated maintenance timers are built into the controller
- ✓ BDI calculations performed within controller
- ✓ Estimates motor temperature based on field resistance and cuts back maximum speed if the motor is overheated
- ✓ Diagnostic checks for field open and field shorted faults
- ✓ Supports PWM electromagnetic brake with maximum continuous current of 2 amps
- ✓ Supports Type 4 throttle
- ✓ Active precharge of controller capacitor bank extends life of main contactor
- ✓ Compatibility with Curtis 1307/1311 handheld programmers for quick and easy testing, diagnostics, and parameter adjustment
- ✓ MultiMode™ allows four user-selectable vehicle operating modes
- ✓ Continuous armature current control, reducing arcing and brush wear
- ✓ Complete diagnostics through the handheld programmer, the built-in Status LED, and the optional 840 Spyglass display
- ✓ Two fault outputs provide diagnostics to remotely mounted displays
- ✓ Regenerative braking allows shorter stopping distances, increases battery charge, and reduces motor heating
- ✓ Automatic braking when throttle is reduced provides a compression braking feel and enhances safety
- ✓ Brake/Drive Interlock meets ISO stopping distance requirements
- ✓ Ramp restraint feature provides automatic electronic braking that restricts vehicle movement while in neutral
- ✓ Meets EEC fault detect requirements
- ✓ Linear cutback of motor drive current during overtemperature or undervoltage

- ✓ Linear cutback of regenerative braking current during overvoltage
- ✓ High pedal disable (HPD) and static return to off (SRO) interlocks prevent vehicle runaway at startup
- ✓ Internal and external watchdog circuits ensure proper software operation
- ✓ Fully protected inputs and short-circuit protected output drivers.

Curtis Model 840 Spyglass Display [optional]

- ✓ 3-wire serial interface
- ✓ Sequences between hourmeter, BDI, and error displays
- ✓ Single alphanumeric, non-backlit, 8 character, 5 mm LCD display for hourmeter, BDI, and fault messages
- ✓ Display updated by dedicated unidirectional serial port
- ✓ Available in 52 mm round case, DIN case, and as a bare board, each with an 8-pin Molex connector; cases feature front seal to IP65 and rear seal to IP40; shock and vibration protection to SAE J1378
- ✓ Operating temperature range -10°C to 70°C; models with lower temperature ratings available for freezer applications

Familiarity with your Curtis controller will help you install and operate it properly. We encourage you to read this manual carefully. If you have questions, please contact the Curtis office nearest you.

2

INSTALLATION AND WIRING

MOUNTING THE CONTROLLER

The controller can be oriented in any position, but **the location should be carefully chosen to keep the controller as clean and dry as possible. If a clean, dry mounting location cannot be found, a cover must be used to shield the controller from water and contaminants.** When selecting the mounting position, be sure to also take into consideration (1) that access is needed at the front of the controller to plug the programmer into its connector, and (2) that the built-in Status LED is visible only through the view port in the label on top of the controller.

The outline and mounting hole dimensions for the 1243_{GEN2} controller are shown in Figure 2. To ensure full rated power, the controller should be fastened to a clean, flat metal surface with three 6 mm (1/4") diameter screws, using the holes provided.

Fig. 2 *Mounting dimensions, Curtis 1243_{GEN2} controller.*

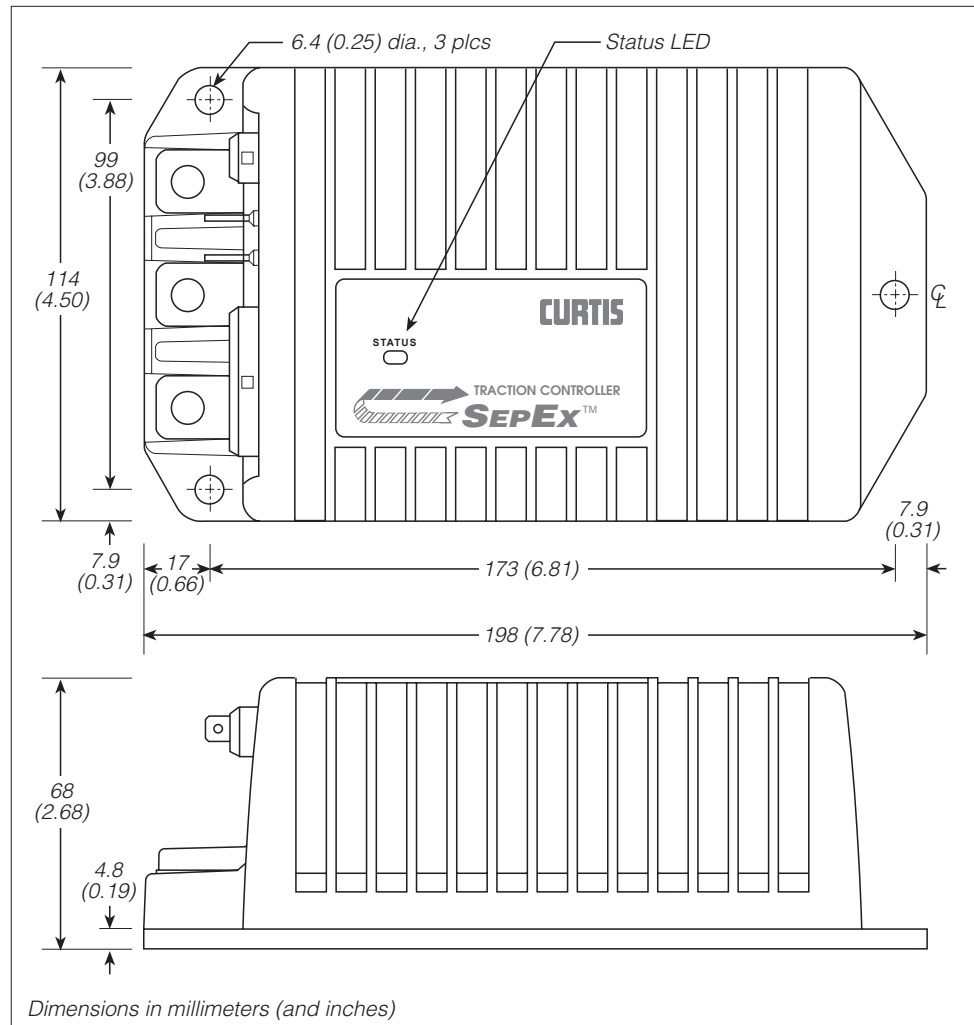

The mounting surface must be at least a 300×300×3 mm (12"×12"×1/8") aluminum plate, or its equivalent, and subjected to a minimum 3 mph airflow to meet the specified time/current ratings. Although not usually necessary, a thermal joint compound can be used to improve heat conduction from the controller heatsink to the mounting surface.

You will need to take steps during the design and development of your end product to ensure that its EMC performance complies with applicable regulations; suggestions are presented in Appendix A.



The 1243^{GEN2} controller contains **ESD-sensitive components**. Use appropriate precautions in connecting, disconnecting, and handling the controller. See installation suggestions in Appendix A for protecting the controller from ESD damage.



Working on electric vehicles is potentially dangerous. You should protect yourself against runaways, high current arcs, and outgassing from lead acid batteries:

RUNAWAYS — Some conditions could cause the vehicle to run out of control. Disconnect the motor or jack up the vehicle and get the drive wheels off the ground before attempting any work on the motor control circuitry.

HIGH CURRENT ARCS — Electric vehicle batteries can supply very high power, and arcs can occur if they are short circuited. Always open the battery circuit before working on the motor control circuitry. Wear safety glasses, and use properly insulated tools to prevent shorts.

LEAD ACID BATTERIES — Charging or discharging generates hydrogen gas, which can build up in and around the batteries. Follow the battery manufacturer's safety recommendations. Wear safety glasses.

CONNECTIONS

Low Current Connections

A 16-pin Molex low current connector in the controller provides the low current logic control connections:

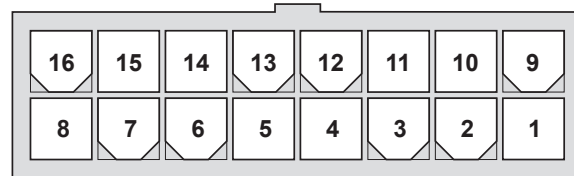

Pin 1	load sensor input [optional]
Pin 2	Fault 1 output / pump input
Pin 3	Fault 2 output
Pin 4	main contactor driver output
Pin 5	throttle: 3-wire pot high
Pin 6	throttle: 0–5V; pot wiper
Pin 7	throttle: pot low
Pin 8	auxiliary driver output (typically used for an electromagnetic brake)
Pin 9	Mode Select 2 input
Pin 10	emerg. reverse check output [optional]
Pin 11	reverse input
Pin 12	forward input
Pin 13	emergency reverse input
Pin 14	Mode Select 1 input
Pin 15	interlock input
Pin 16	keyswitch input (KSI)

The mating connector is a 16-pin Molex Mini-Fit Jr. connector p/n 39-01-2165 using type 5556 terminals.

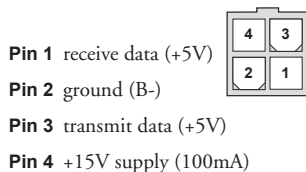

A 4-pin low power connector is provided for the handheld programmer. A complete 1311 programmer kit, including the appropriate connecting cable, can be ordered from Curtis.

The 4-pin connector can also be used for the Spyglass display. The display is unplugged when the programmer is used.

High Current Connections

Three tin-plated solid copper bus bars are provided for high current connections to the battery (**B+** and **B-**) and the motor armature (**M-**). Cables are fastened to the bus bars by M8 bolts. The 1243_{GEN2} case provides the capture nuts required

for the M8 bolts. The maximum bolt insertion depth below the surface of the bus bar is 1.3 cm (1/2"). Bolt shafts exceeding this length may damage the controller. The torque applied to the bolts should not exceed 16.3 N·m (12 ft-lbs).

Two 1/4" quick connect terminals (**S1** and **S2**) are provided for the connections to the motor field winding.

WIRING: Standard Configuration

Figure 3 shows the typical wiring configuration for most applications. **For walkie applications** the interlock switch is typically activated by the tiller, and an emergency reverse switch on the tiller handle provides the emergency reverse signal.

For rider applications the interlock switch is typically a seat switch or a foot switch, and there is no emergency reverse.

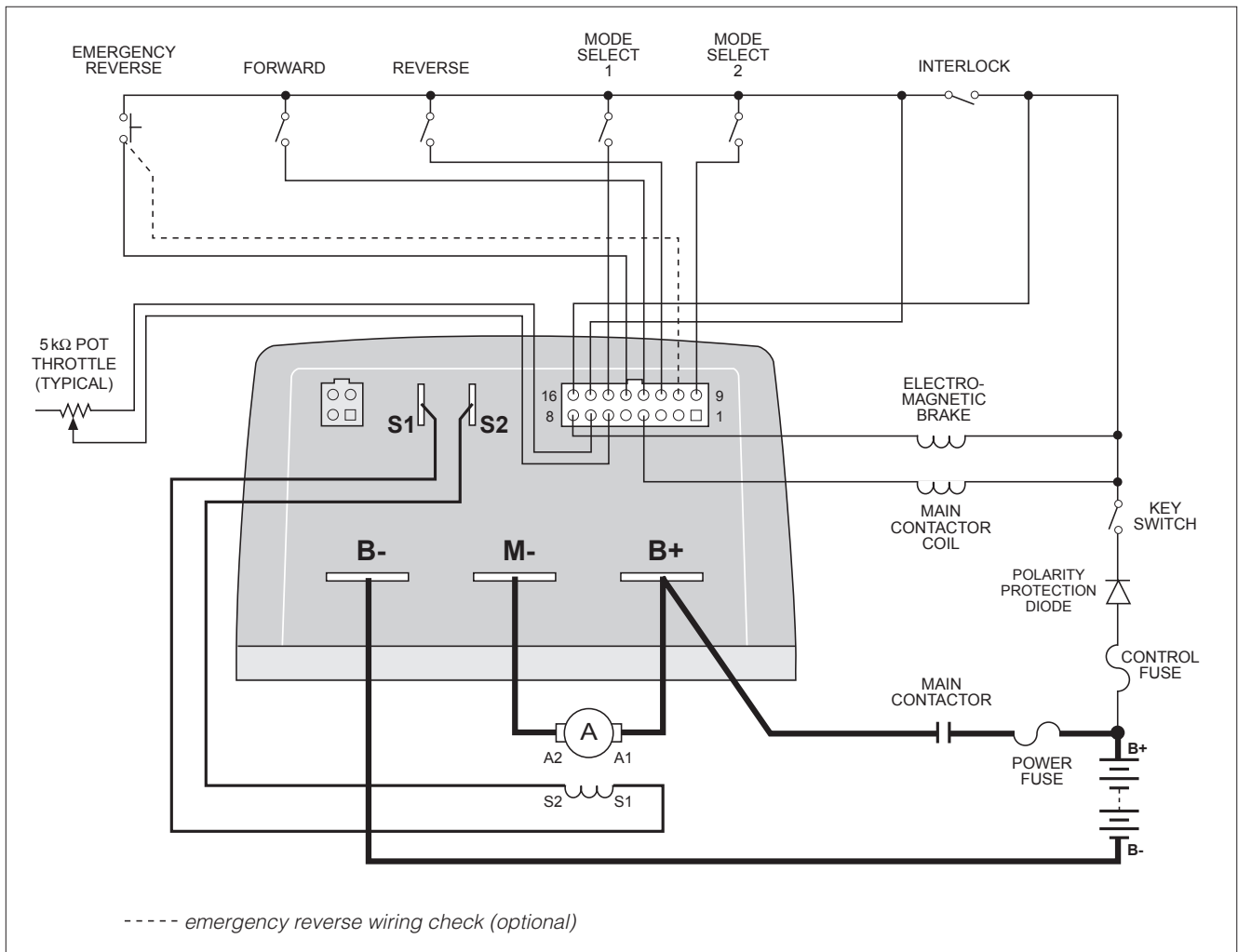

Fig. 3 Standard wiring configuration, Curtis 1243GEN2 controller.

Standard Power Wiring

Motor armature wiring is straightforward, with the armature's A1 connection going to the controller's **B+** bus bar and the armature's A2 connection going to the controller's **M-** bus bar.

The motor's field connections (S1 and S2) are less obvious. The direction of vehicle travel with the forward direction selected will depend on how the motor's S1 and S2 connections are made to the controller's two field terminals (**S1** and **S2**) and how the motor shaft is connected to the drive wheels through the vehicle's drive train. **CAUTION:** The polarity of the **S1** and **S2** connections will affect the operation of the emergency reverse feature. The forward and reverse switches and the **S1** and **S2** connections must be configured so that the vehicle drives away from the operator when the emergency reverse button is pressed.



Standard Control Wiring

Wiring for the input switches and contactors is shown in Figure 3; the pins are identified on page 6. In the standard wiring configuration, the auxiliary driver at Pin 8 is used to drive an electromagnetic brake.

The main contactor coil must be wired directly to the controller as shown in Figure 3. The controller checks for welded or missing contactor faults and uses the main contactor coil driver output to disconnect the battery from the controller and motor when specific faults are present. If the main contactor coil is not wired to Pin 4, the controller will not be able to open the main contactor in serious fault conditions and the system will therefore not meet EEC safety requirements.

WIRING: Throttle

Wiring for various throttles is described below. They are categorized as Type 1, 2, 3, and 4 throttles in the program menu of the handheld programmer. Note: In the text, throttles are identified by their nominal range and not by their actual active range.

Appropriate throttles for use with the 1243_{GEN2} controller include two-wire 5k Ω –0 throttles (“Type 1”); 0–5V throttles, current source throttles, three-wire potentiometer throttles, and electronic throttles wired for single-ended operation (all “Type 2”); two-wire 0–5k Ω throttles (“Type 3”), and 0–5V and three-wire potentiometer throttles wired for wigwag operation (“Type 4”). The operating specifications for these throttle types are summarized in Table 1. Refer to Section 3: Programmable Parameters, for information on the effects of the Throttle Deadband and Throttle Max parameters on the minimum and maximum throttle thresholds.

If the throttle you are planning to use is not covered, contact the Curtis office nearest you.

Table 1 THROTTLE WIPER INPUT THRESHOLD VALUES

THROTTLE TYPE	PARAMETER	MAXIMUM THROTTLE FAULT	THROTTLE DEADBAND (0% speed request)	HPD (25% throttle active range)	THROTTLE MAX (100% modulation)	MINIMUM THROTTLE FAULT
1 (5k Ω –0)	Wiper Voltage	5.00 V	3.80 V	2.70 V	0.20 V	0.06 V
	Wiper Resistance	7.50 k Ω	5.50 k Ω	3.85 k Ω	0 k Ω	—
2 (0–5V)	Wiper Voltage	0.06 V	0.20 V	1.50 V	5.00 V	5.80 V
	Wiper Resistance	—	—	—	—	—
3 (0–5k Ω)	Wiper Voltage	0.06 V	0.20 V	1.30 V	3.80 V	5.00 V
	Wiper Resistance	—	0 k Ω	1.65 k Ω	5.50 k Ω	7.50 k Ω
4 (0–5V)	Wiper Voltage	0.50 V	2.50 V (fwd) * 2.50 V (rev) *	3.10 V (fwd) 1.90 V (rev)	4.40 V (fwd) 0.60 V (rev)	4.50 V
	Wiper Resistance	—	—	—	—	—

Notes: The Throttle Deadband and Throttle Max thresholds are valid for nominal 5k Ω potentiometers or 5V sources with the default Throttle Deadband and Throttle Max parameter settings of 0% and 100% respectively. These threshold values will change with variations in the Throttle Deadband and Throttle Max parameter settings.

The HPD thresholds are 25% of the active throttle range and therefore dependent on the programmed Throttle Deadband and Throttle Max settings (which define the active range).

The wiper voltage is measured with respect to B-.

The wiper resistance is measured from pot low to pot wiper. The potentiometer must be disconnected from the controller when making this measurement.

* With a 0% Throttle Deadband setting, there is no neutral point on a Type 4 throttle. A Throttle Deadband setting of at least 8% is recommended for Type 4 throttles.

5k Ω -0 Throttle (“Type 1”)

The 5k Ω -0 throttle (called a “Type 1” throttle in the programming menu of the 13XX programmer) is a 2-wire resistive throttle that connects between the Pot Wiper and Pot Low pins (Pins 6 and 7), as shown in Figure 4. It doesn’t matter which wire goes on which pin. For Type 1 throttles, zero speed corresponds to 5 k Ω measured between the two pins and full speed corresponds to 0 Ω . (Note: This wiring is also shown in the standard wiring diagram, Figure 3.)

Fig. 4 Wiring for 5k Ω -0 throttle (“Type 1”).

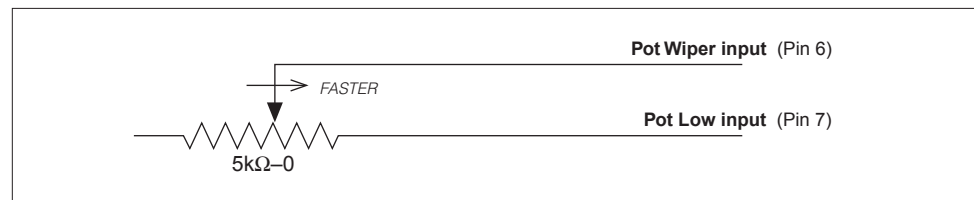

In addition to accommodating the basic 5k Ω -0 throttle, the Type 1 throttle is the easiest with which to implement a wigwag-style throttle. Using a 20k Ω potentiometer wired as shown in Figure 5, the pot wiper can be set such that the controller has 5 k Ω between Pins 6 and 7 when the throttle is in the neutral position. The throttle mechanism can then be designed such that rotating it either forward or back decreases the resistance between Pins 6 and 7, which increases the controller output. The throttle mechanism must provide signals to the controller’s forward and reverse inputs independent of the throttle pot resistance. The controller will not sense direction from the pot resistance.

Fig. 5 Wiring for 20k Ω potentiometer used as a wigwag-style throttle (“Type 1”).

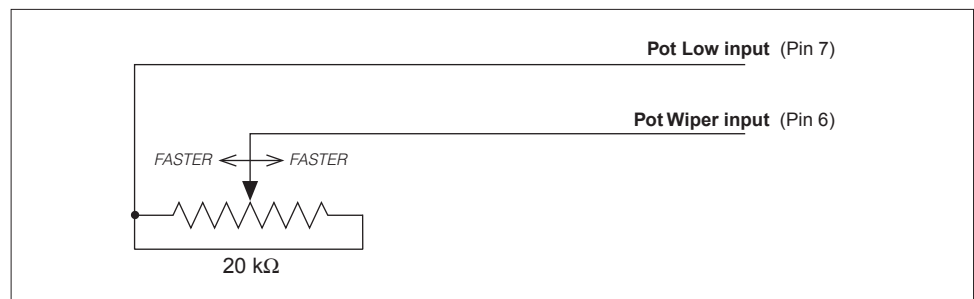

Broken wire protection is provided by the controller sensing the current flow from the wiper input through the potentiometer and into the Pot Low pin. If the Pot Low input current falls below 0.65 mA or its voltage below 0.06 V, a throttle fault is generated and the controller is disabled. Note: The Pot Low pin (Pin 7) must not be tied to ground (B-).

0–5V, Current Source, 3-Wire Potentiometer, and Electronic Throttles (“Type 2”)

With these throttles (“Type 2” in the programming menu) the controller looks for a voltage signal at the wiper input (Pin 6). Zero speed will correspond to 0 V and full speed to 5 V (measurements made relative to B-). A voltage source, current source, 3-wire potentiometer, or electronic throttle can be used with this throttle type. The wiring for each is slightly different and each has varying levels of throttle fault detection associated with it.

0–5V Throttle

Two ways of wiring the 0–5V throttle are shown in Figure 6. The active range for this throttle is from 0.2 V (at 0% Throttle Deadband) to 5.0 V (at 100% Throttle Max), measured relative to B-.

Fig. 6 *Wiring for 0–5V throttles (“Type 2”).*

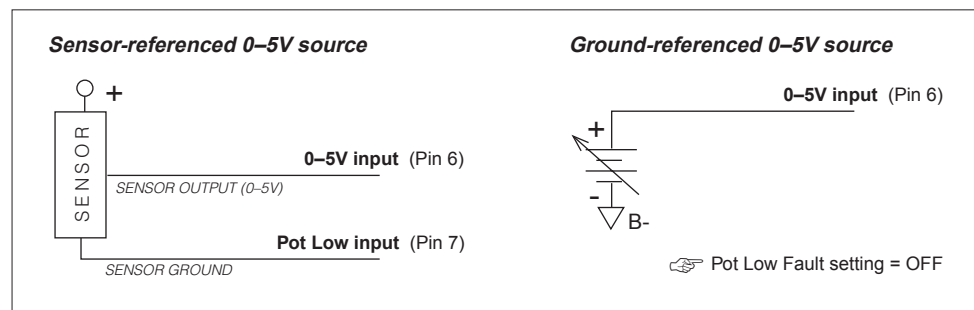

Sensor-referenced 0–5V throttles must provide a Pot Low current greater than 0.65 mA to prevent shutdown due to pot faults. It is recommended that the maximum Pot Low current be limited to 55 mA to prevent damage to the Pot Low circuitry.

Ground-referenced 0–5V throttles require setting the Pot Low Fault parameter (see Section 3, page 38) to Off; otherwise the controller will register a throttle fault and will shut down. For ground-referenced 0–5V throttles, the controller will detect open breaks in the wiper input but cannot provide full throttle fault protection. Also, the controller recognizes the voltage between the wiper input and B- as the applied throttle voltage and not the voltage from the voltage source relative to the Pot Low input.

For either throttle input, if the 0–5V throttle input (Pin 6) exceeds 5.5 V relative to B-, the controller will register a fault and shut down.

Current Sources As Throttles

A current source can also be used as a throttle input, wired as shown in Figure 7. A resistor, R_{throttle} , must be used to convert the current source value to a voltage. The resistor should be sized to provide a 0–5V signal variation over the full current range.

The Pot Low Fault parameter (see Section 3, page 38) must be set to Off; otherwise the controller will register a throttle fault and will shut down. It is the responsibility of the vehicle manufacturer to provide appropriate throttle fault detection in applications using a current source as a throttle.

Fig. 7 Wiring for current source throttle (“Type 2”).

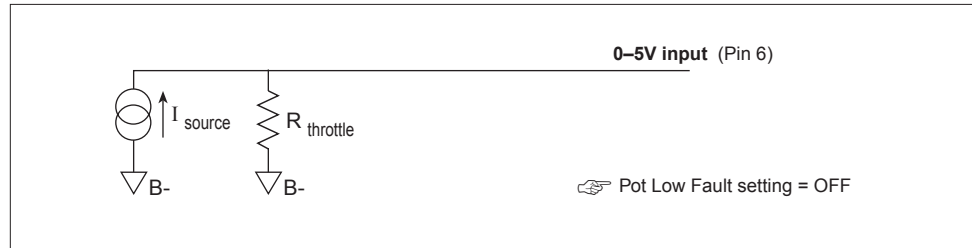

3-Wire Potentiometer (1kΩ–10kΩ) Throttle

A 3-wire pot with a total resistance value anywhere between 1 kΩ and 10 kΩ can be used, wired as shown in Figure 8. The pot is used in its voltage divider mode, with the voltage source and return being provided by the 1243^{GEN2} controller. Pot High (Pin 5) provides a current limited 5V source to the pot, and Pot Low (Pin 7) provides the return path. If a 3-wire pot is used and the Pot Low Fault parameter (see Section 3, page 38) is set to On, the controller will provide full throttle fault protection in accordance with EEC requirements. Note: the Pot Low pin (Pin 7) must not be tied to ground (B-).

Fig. 8 Wiring for 3-wire potentiometer throttle (“Type 2”).

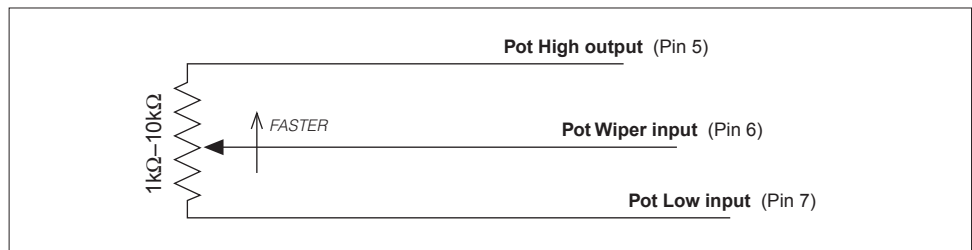

Curtis ET-XXX Electronic Throttle

The Curtis ET-XXX provides a 0–5V throttle and forward/reverse inputs for the 1243_{GEN2} controller. Wiring for the ET-XXX is shown in Figure 9. When an electronic throttle is used, the Pot Low Fault parameter (see Section 3, page 38) must be set to Off; otherwise the controller will register a throttle fault and will shut down.

Fig. 9 *Wiring for Curtis ET-XXX electronic throttle (“Type 2”).*

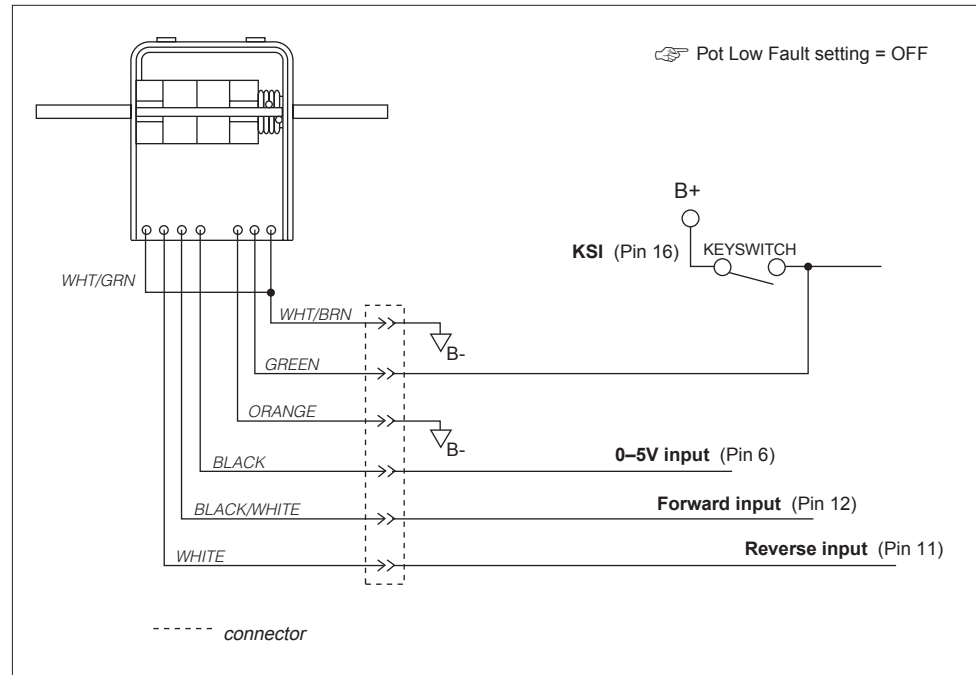

There is no fault detection built into the ET-XXX, and the controller will detect only open wiper faults. It is the responsibility of the vehicle manufacturer to provide any additional throttle fault detection necessary.

The ET-XXX can be integrated into a control head to provide wigwag-style throttle control. Alternatively, a complete control head assembly is available from Curtis. This control head assembly—the CH series—combines the ET-XXX throttle with a variety of standard control head switch functions for use in walkie and lift truck applications.

0–5k Ω Throttle (“Type 3”)

The 0–5k Ω throttle (“Type 3” in the programming menu) is a 2-wire resistive throttle that connects between the Pot Wiper and Pot Low pins (Pins 6 and 7) as shown in Figure 10. Zero speed corresponds to 0 Ω measured between the two pins and full speed corresponds to 5 k Ω . This throttle type is not appropriate for use in wigwag-style applications.

Broken wire protection is provided by the controller sensing the current flow from the wiper input through the potentiometer and into the Pot Low pin. If the Pot Low input current falls below 0.65 mA or its voltage below 0.06 V,

Fig. 10 *Wiring for 0–5kΩ throttle (“Type 3”).*

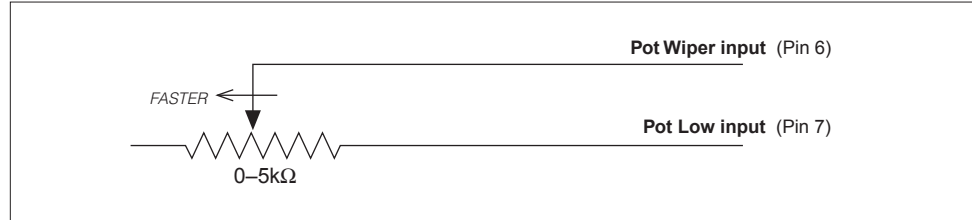

a throttle fault is generated and the controller is disabled. Note: The Pot Low pin (Pin 7) must not be tied to ground (B-).

Wigwag-Style 0–5V Voltage Source and 3-Wire Pot Throttle (“Type 4”)

These throttles (“Type 4” in the programming menu) operate in true wigwag style. No signals to the controller’s forward and reverse inputs are required; the action is determined by the wiper input value. The interface to the controller for Type 4 devices is similar to that for Type 2 devices. The neutral point will be with the wiper at 2.5 V, measured between Pin 6 and B-.

The controller will provide increasing forward speed as its wiper input value (Pin 6) is increased, with maximum forward speed reached at 4.5 V. The controller will provide increasing reverse speed as the wiper input value is decreased, with maximum reverse speed reached at 0.5 V. The minimum and maximum wiper voltage must not exceed the 0.5V and 4.5V fault limits.

When a 3-wire pot is used and the Pot Low Fault parameter (see Section 3, page 36) is set to On, the controller provides full fault protection for Type 4 traction throttles. Any potentiometer value between 1 kΩ and 10 kΩ is supported. When a voltage throttle is used, it is the responsibility of the OEM to provide appropriate throttle fault detection.

Note: If your Type 4 throttle has an internal neutral switch, this internal neutral switch should be wired to the forward switch input (Pin 12). The controller will behave as though no throttle is requested when the neutral switch is high, and will use the throttle value when the neutral switch is low.

WIRING: Fault Outputs

The 1243_{GEN2} has two fault signal outputs (Pins 2 and 3), which can be used to provide diagnostic information to a display panel. These current-sinking outputs can drive LEDs or other loads requiring less than 10 mA. Since these outputs are intended to drive LEDs, each contains a dropping resistor; as a result, these outputs will not pull down to B-. Wiring is shown in Figure 11.

The Fault 1 and Fault 2 outputs can be programmed to display fault information in either of two formats: Fault Code format or Fault Category format (see Section 3, page 51).

Alternatively, Pin 2 can be used to provide a pump input signal (see pump meter parameter, Section 3, page 48); Pin 3 can be used to interface an external auxiliary enable circuit (see BDI lockout parameter, Section 3, page 51).

Fig. 11 Wiring for fault outputs, when used to drive LEDs. Alternatively, Pin 2 can be used for a pump meter input, and Pin 3 can be used to interface an external enable circuit.

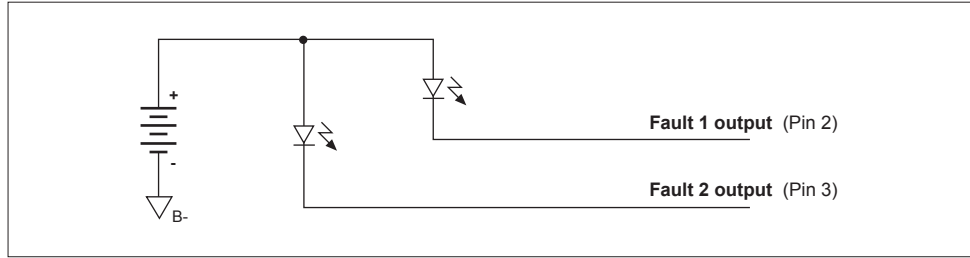

WIRING: Spyglass Display

The Curtis 840 Spyglass features an 8-character LCD display that sequences between hourmeter, BDI %, and fault messages. Depending on the model, either three or six indicator LEDs are also located on the face of the gauge. See Section 7 (Diagnostics and Troubleshooting) for more information on the Spyglass displays.

The mating 8-pin connector is Molex 39-01-2085, with 39-00-0039 (18–24 AWG) pins.

Fig. 12 Wiring guide and mounting dimensions for Curtis Spyglass (6-LED model shown; dimensions and wiring are identical for the 3-LED model).

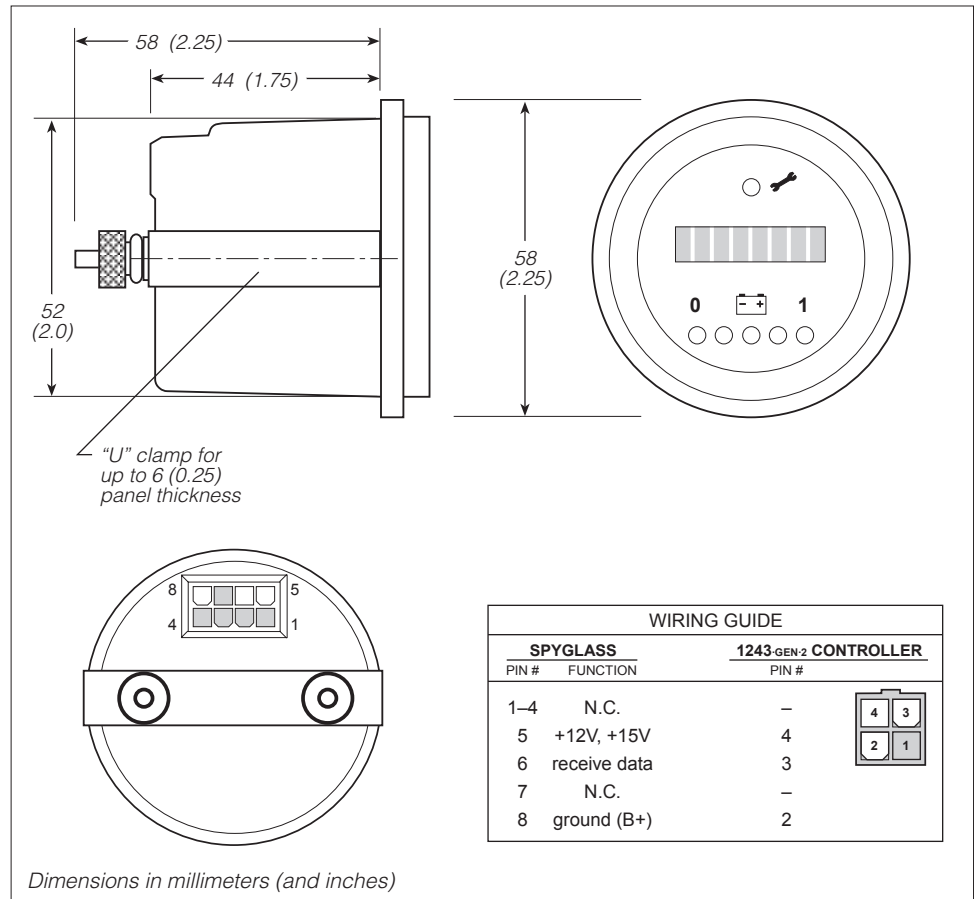

WIRING: Emergency Reverse

To implement the emergency reverse feature, Pin 13 (the emergency reverse input) must be connected to battery voltage as shown in the standard wiring diagram, Figure 3.

The controller provides maximum braking torque as soon as the emergency reverse switch is closed. The vehicle will then be automatically driven in the reverse direction at the programmed emergency reverse current limit until the emergency reverse switch is released.



CAUTION: The polarity of the **S1** and **S2** connections will affect the operation of the emergency reverse feature. The forward and reverse switches and the **S1** and **S2** connections must be configured so that the vehicle drives away from the operator when the emergency reverse button is pressed.

WIRING: Emergency Reverse Check

An optional wire connected directly to the emergency reverse switch provides for broken wire detection when that feature is programmed On (see Section 3, page 43). The emergency reverse check output wire periodically pulses the emergency reverse circuit to check for continuity in the wiring. If there is no continuity, the controller output is inhibited until the wiring fault is corrected.

The emergency reverse check wire is connected to Pin 10 as shown by the dotted line in the standard wiring diagram, Figure 3. If the option is selected and the check wire is not connected, the vehicle will not operate. If the option is not selected and the check wire is connected, no harm will occur—but continuity will not be checked.

WIRING: Auxiliary Driver

The 1243^{GEN2} provides an auxiliary driver at Pin 8. This low side driver is designed to energize an electromagnetic brake coil, as shown in the standard wiring diagram (Figure 3). The output is rated at 2 amps and is overcurrent protected. A coil suppression diode is provided internally to protect the driver from inductive spikes generated at turn-off. The recommended wiring is shown in the standard wiring diagram, Figure 3. The contactor coil or driver load should not be connected directly to B+, which would cause the controller to be always biased On via a path through the coil suppression diode to the KSI input.

Although it is typically used to drive an EM brake, the auxiliary driver can be used to drive a pump contactor or hydraulic steering assist in applications not requiring an EM brake.

Note: Because the auxiliary driver is typically used for an EM brake, the programmable parameters related to this driver are described in the electromagnetic brake parameter group; see page 28.

CONTACTOR, SWITCHES, and OTHER HARDWARE

Main Contactor

A main contactor should be used with any 1243^{GEN2} controller; otherwise the controller's fault detects will not be able to fully protect the controller and motor drive system from damage in a fault condition. The main contactor allows the controller and motor to be disconnected from the battery. This provides a significant safety feature in that the battery power can be removed from the drive system if a controller or wiring fault results in full battery power being applied to the motor. If the Contactor Diagnostics parameter (see Section 3, page 40) is On, the controller will conduct a missing contactor check and a welded contactor check each time the main contactor is requested to close and will not proceed with the request if a fault is found.

A single-pole, single-throw (SPST) contactor with silver-alloy contacts, such as an Albright SW80 or SW180—available from Curtis—is recommended for use as the main contactor. The contactor coils should be specified with a continuous rating at the nominal battery pack voltage.

The main contactor coil driver output (Pin 4) is rated at 2 amps, is over-current protected, and is checked for open coil faults. A built-in coil suppression diode is connected between the main contactor coil driver output and the keyswitch input. This protects the main contactor coil driver from failure due to inductive voltage kickback spikes when the contactor is turned off.

Keyswitch and Interlock Switch

The vehicle should have a master on/off switch to turn the system off when not in use. The keyswitch input provides logic power for the controller.

The interlock switch—which is typically implemented as a tiller switch, deadman footswitch, or seatswitch—provides a safety interlock for the system.

The keyswitch and interlock switch provide current to drive the main contactor coil and all other output driver loads as well as the controller's internal logic circuitry and must be rated to carry these currents.

Forward, Reverse, Mode Select, and Emergency Reverse Switches

These input switches can be any type of single-pole, single-throw (SPST) switch capable of switching the battery voltage at 10 mA. Typically the emergency reverse switch is a momentary switch, active only while it is being pressed.

Reverse Polarity Protection Diode

For reverse polarity protection, a diode should be added in series between the battery and KSI. This diode will prohibit main contactor operation and current flow if the battery pack is accidentally wired with the B+ and B- terminals exchanged. It should be sized appropriately for the maximum contactor coil and fault diode currents required from the control circuit. The reverse polarity protection diode should be wired as shown in the standard wiring diagram, Figure 3 (page 7).

Circuitry Protection Devices

To protect the control circuitry from accidental shorts, a low current fuse (appropriate for the maximum current draw) should be connected in series between the battery and KSI. Additionally, a high current fuse should be wired in series with the main contactor to protect the motor, controller, and batteries from accidental shorts in the power system. The appropriate fuse for each application should be selected with the help of a reputable fuse manufacturer or dealer. The standard wiring diagram, Figure 3, shows the recommended location for each fuse.

Mode Select Switch Operation

The two mode select switches (Mode Select 1 and Mode Select 2) together define the four operating modes. The switch combinations are shown in Table 2.

OPERATING MODE	MODE SELECT SWITCH 1	MODE SELECT SWITCH 2
MultiMode™ 1	OPEN	OPEN
MultiMode™ 2	CLOSED	OPEN
MultiMode™ 3	OPEN	CLOSED
MultiMode™ 4	CLOSED	CLOSED

Load Sensor [optional]

The 1243_{GEN2} provides a load sensor input at Pin 1. The controller can be programmed to vary the strength of regen braking depending on the load sensor input. The load sensor, if one is used, should be sized to handle your application's maximum expected load without exceeding 5 V.

3

PROGRAMMABLE PARAMETERS

The 1243^{GEN2} controller has a number of parameters that can be programmed using a Curtis handheld programmer. These programmable parameters allow the vehicle's performance characteristics to be customized to fit the needs of individual vehicles or vehicle applications.

The OEM can specify the default value for each parameter and can also designate whether a parameter will have User or OEM access rights. Accordingly, programmers are available in User and OEM versions. The User programmer can adjust only those parameters with User access rights, whereas the OEM programmer can adjust all the parameters. For information about 1311 programmer operation, see Appendix B.

The MultiMode™ feature of the 1243^{GEN2} controller allows operation in four distinct modes. These modes can be programmed to provide four different sets of operating characteristics, which can be useful for operating in different conditions, such as slow precise indoor maneuvering in Mode 1; faster, long distance, outdoor travel in Mode 4; and application-specific special conditions in Modes 2 and 3. Eight parameters can be configured independently in each of the four modes:

- acceleration rate (M1–M4)
- braking current limit (M1–M4)
- braking rate (M1–M4)
- deceleration rate (M1–M4)
- drive current limit (M1–M4)
- maximum forward speed (M1–M4)
- maximum reverse speed (M1–M4)
- restraint (M1–M4).

To better describe their interrelationships, the individual parameters are grouped into categories as follows:

- *Battery Parameters*
- *Acceleration Parameters*
- *Braking Parameters*
- *Interlock Braking Parameters*
- *Electromagnetic Brake Parameters*
- *Speed Parameters*
- *Throttle Parameters*
- *Field Parameters*
- *Contactors Parameters*
- *Sequencing Fault Parameters*
- *Emergency Reverse Parameters*
- *Motor Protection Parameters*
- *Hourmeter Parameters*
- *BDI Parameters*
- *Fault Code Parameters*

Battery Parameter p. 21

Battery Voltage

Acceleration Parameters p. 21

Drive Current Limit, M1–M4
 Acceleration Rate, M1–M4
 Quick Start
 Current Ratio

Braking Parameters p. 23

Braking Current Limit, M1–M4
 Deceleration Rate, M1–M4
 Throttle Deceleration Rate
 Restraint, M1–M4
 Braking Rate, M1–M4
 Taper Rate
 Variable Braking

Interlock Braking Parameters p. 26

Interlock Braking Rate
 Max. Forward Regen
 Max. Reverse Regen
 Min. Forward Regen
 Min. Reverse Regen
 Max. Load Volts
 Min. Load Volts

Electromagnetic Brake Parameters p. 28

Auxiliary Driver Type
 Electromagnetic Brake PWM
 Auxiliary Driver Delay
 Interlock Brake Delay

Speed Parameters p. 31

Max. Forward Speed, M1–M4
 Max. Reverse Speed, M1–M4
 Creep Speed
 Load Compensation

Throttle Parameters p. 32

Throttle Type
 Throttle Deadband
 Throttle Max
 Throttle Map
 Pot Low Fault

Field Parameters p. 38

Min. Field Current Limit
 Max. Field Current Limit
 Field Map Start
 Field Map
 Field Check

Main Contactor Parameters p. 40

Main Contactor Interlock
 Main Contactor Open Delay
 Main Contactor Diagnostics

Sequencing Fault Parameters ... p. 41

Anti-Tiedown
 High Pedal Disable (HPD)
 Static Return to Off (SRO)
 Sequencing Delay

Emergency Reverse Parameters p. 43

Emerg. Reverse Current Limit
 Emerg. Reverse Check
 Emerg. Reverse Direction Interlock

Motor Protection Parameters ... p. 44

Warm Speed
 Motor Warm Resistance
 Motor Hot Resistance
 Motor Resistance Compensation

Hourmeter Parameters p. 45

Adjust Hours High
 Adjust Hours Middle
 Adjust Hours Low
 Set Total Hours
 Set Traction Hours
 Total Service Hours
 Traction Service Hours
 Total Disable Hours
 Traction Disable Hours
 Traction Fault Speed
 Service Total
 Service Traction
 Hourmeter Type
 Pump Meter

BDI Parameters p. 49

Full Voltage
 Empty Voltage
 Reset Voltage
 Battery Adjust
 BDI Disable
 BDI Limit Speed

Fault Code Parameters p. 51

Fault Code
 BDI Lockout



Individual parameters are described in the following text in the order they are listed on this page. They are listed by the abbreviated names that are displayed in the programmer's Program Menu. Not all of these parameters are displayed on all controllers; the list for any given controller depends on its specifications.

The programmer displays the parameters in a different order. For a list of the individual parameters in the order in which they appear in the Program Menu, see Section 6: Programmer Menus.

Battery Parameter

VOLTAGE

The **battery voltage** parameter sets the overvoltage and undervoltage protection thresholds for the controller and battery. Overvoltage protection cuts back regenerative braking to prevent damage to batteries and other electrical system components due to overvoltage; undervoltage protection prevents systems from operating at voltages below their design thresholds. The battery voltage parameter can be set at 2 or 3, and should always be set to the system's nominal battery pack voltage:

SETTING	NOMINAL BATTERY PACK VOLTAGE
2	24V
3	36V

Acceleration Parameters

M1–M4, DRIVE C/L

The **drive current limit** parameter allows adjustment of the maximum current the controller will supply to the motor during drive operation. This parameter can be limited to reduce the maximum torque applied to the drive system by the motor in any reduced performance mode. The drive current limit is adjustable from 50 amps up to the controller's full rated armature current. (The full rated current depends on the controller model; see specifications in Table D-1.)

The drive current limit is tuned as part of the vehicle performance adjustment process (Section 5).

M1–M4, ACCEL RATE

The **acceleration rate** defines the time it takes the controller to accelerate from 0% drive output to 100% drive output. A larger value represents a longer acceleration time and a gentler start. Fast starts can be achieved by reducing the acceleration time, i.e., by adjusting the accel rate to a smaller value. The acceleration rate is adjustable from 0.1 to 3.0 seconds.

The acceleration rate is tuned as part of the vehicle performance adjustment process (Section 5).

QUICK START

Upon receiving a sudden high throttle demand from neutral, the **quick start** function causes the controller to momentarily exceed its normal acceleration rate, in order to overcome vehicle inertia. The quick start algorithm is applied each time the throttle passes through neutral and the controller is not in braking

mode. If the controller is in braking mode, the quick start function is disabled, allowing normal braking to occur. Quick start is adjustable from 0 to 10. Increasing the value will “liven” the vehicle’s acceleration response to fast throttle movements.

The quick start parameter is tuned as part of the vehicle performance adjustment process (Section 5).

NOTE: Quick start is not a MultiMode™ parameter, and its value will therefore affect all four operating modes.

CURRENT RATIO

The **current ratio** parameter defines how much of the programmed drive current will be available to the motor at reduced throttle requests. The current ratio parameter can be set to 1, 2, 3, or 4. These settings correspond to the following ratios:

SETTING	RATIO
1	1 : 1
2	2 : 1
3	4 : 1
4	8 : 1

For example, with the current ratio set at 1 with 20% throttle requested, 20% of the battery voltage and 20% of the drive current will be allowed to flow in the motor (assuming a 50% throttle map setting). If the current ratio is set at 2 under these same conditions, 40% of the current will be available; if it is set at 3, 80%. The controller will not allow more than the programmed drive current to flow in the motor. If the current ratio is set at 4 with 20% throttle requested, the controller will allow only 100% of the drive current and not 160%.

High current ratio values will allow quicker startup response and improved ramp climbing with partial throttle, but may cause too much jumpiness.

The current ratio parameter is tuned as part of the vehicle performance adjustment process (Section 5).

Note: Current ratio is only effective in drive; it does not affect regen.

Braking Parameters

The seven Braking parameters affect the regenerative braking that is initiated when the throttle is reduced or when the direction is reversed while the vehicle is being driven. During regen braking, armature current flows toward the battery.

M1–M4, BRAKE C/L

The **braking current limit** parameter adjusts the maximum current the controller will supply to the motor during regen braking. The braking current limit is adjustable from 50 amps up to the controller's full rated braking current. (The full rated current depends on the controller model; see specifications in Table D-1.) The braking current limit is tuned as part of the vehicle performance adjustment process (Section 5).

M1–M4, DECEL RATE

The **deceleration rate** defines the time it takes the controller to reduce its output to the new throttle request when the throttle is reduced or released. A lower value represents a faster deceleration and thus a shorter stopping distance. The decel rate defines the vehicle's braking characteristic for any reduction in throttle, including to neutral, that does not include a request for the opposite direction. The decel rate is adjustable from 0.1 to 10.0 seconds. The decel rate is tuned as part of the vehicle performance adjustment process (Section 5).

THROTTLE DECEL

The **throttle deceleration rate** parameter adjusts the rate at which the vehicle transitions to braking when throttle is first reduced. If the throttle decel rate is set low, deceleration is initiated abruptly. The transition is smoother if the throttle decel rate is higher; however, setting the throttle decel parameter too high can cause the vehicle to feel uncontrollable when the throttle is released, as it will continue to drive for a short period. The throttle decel rate is adjustable from 0.1 to 1.0 second, with a value of 0.3 or 0.4 working well for most vehicles.

When the armature current goes negative (i.e., at the point when positive torque transitions to negative torque), the normal decel rate goes into effect.

M1–M4, RESTRAINT

Because the 1243_{GEN2} controller is configured to provide regenerative braking, overspeed causes the controller to create a braking current and thus limit or "restrain" the overspeed condition. The **restraint** parameter determines how strongly the controller tries to limit the vehicle speed to the existing throttle setting. It is applicable when throttle is reduced or when the vehicle begins to travel downhill.

At zero throttle, the restraint function tries to keep the motor at zero speed, which helps hold the vehicle from running away down ramps. The higher the restraint parameter value, the stronger the braking force applied to the motor and the slower the vehicle will creep down ramps. This creeping speed depends on the restraint setting, the steepness of the ramp, and the vehicle load weight. The restraint feature can never hold a vehicle perfectly stationary on a ramp and is not intended to replace a mechanical or electromagnetic brake for this purpose.

The restraint parameter establishes a linear mapping of field current to braking current, and is adjustable from the programmed minimum field (Field Min) up to the controller's full rated field current. As shown in Figure 13, it is limited by the programmed maximum field (Field Max). Setting the restraint parameter to a high value will cause strong braking, in an effort to bring the vehicle speed down to the requested speed. Extremely high values may cause the vehicle speed to oscillate ("hunt") while in ramp restraint.

The restraint parameter is tuned as part of the vehicle performance adjustment process (Section 5).

Fig. 13 Ramp restraint maps for controller with Field Min set at 3 amps, Field Max at 18 amps, and braking current limit at 300 amps.

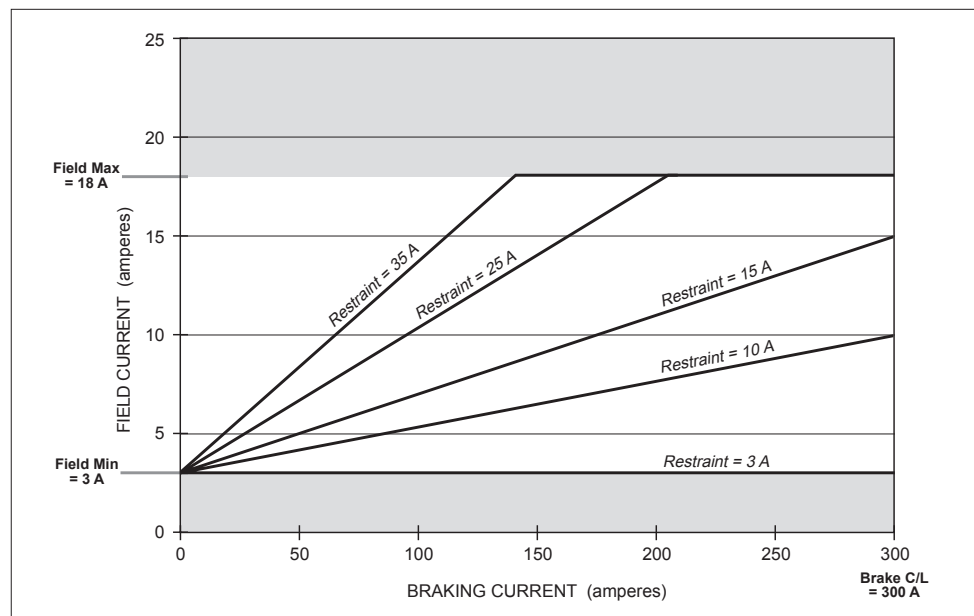

M1–M4, BRAKE RATE

The **braking rate** defines the time it takes the controller to increase from 0% braking output to 100% braking output (as defined by the corresponding mode-specific brake current limit) when a new direction is selected. A larger value represents a longer time and consequently gentler braking. Faster braking is achieved by adjusting the braking rate to a smaller value. The braking rate is adjustable from 0.1 second to 3.0 seconds.

Note: The variable braking parameter must be programmed Off for the braking rate parameter to apply; if variable braking is On, the braking rate will be determined by throttle position rather than the programmed braking rate.

TAPER RATE

The **taper rate** affects direction-reversal at the very end of braking, just before the vehicle stops moving in the original direction. Low taper rate values result in faster, more abrupt direction transitions. Higher taper rate values result in slower and smoother direction transitions. The taper rate is adjustable from 1 to 20. The taper rate is tuned as part of the vehicle performance adjustment process (Section 5).

VARIABLE BRAKE

The **variable braking** parameter defines how the controller will apply braking force when direction-reversal braking is requested. If the variable braking parameter is programmed On, the amount of braking current applied by the controller will be a function of the throttle's position when braking is requested. With variable braking, the operator can use the throttle to control the amount of braking force applied to a moving vehicle. Increasing throttle in the direction opposite to the vehicle's motion will apply increasing amounts of regen braking current to the motor, slowing the vehicle more quickly.

If a fixed amount of braking force is preferred, the variable braking parameter should be programmed Off. With variable braking Off, the controller applies the full braking current specified as soon as braking is requested.

Interlock Braking Parameters

If the interlock switch opens while the vehicle is being driven, the controller uses the motor to apply regenerative braking as soon as the programmed Sequencing Delay (see page 42) expires. This braking—which is called interlock braking—greatly reduces wear on the electromagnetic brake and also enables the vehicle to meet more stringent stopping distance requirements.

As soon as interlock braking brings the motor speed to approximately zero, the electromagnetic brake is applied. Note that for safety, the EM brake will engage after the programmed Interlock Brake Delay (see page 28) even if interlock braking does not bring the motor speed close to zero.

The seven Interlock Braking parameters affect the regen braking that results when the interlock switch is opened while the vehicle is being driven.

INT BRAKE RATE

The **interlock braking rate** defines the time it takes the controller to increase from 0% to 100% braking output (as determined by the max regen current setpoints) when interlock braking is initiated. The interlock braking rate is adjustable from 0.1 to 3.0 seconds.

MAX FWD REGEN

The **maximum forward regen** parameter defines the maximum regenerative current at maximum load while traveling in the forward direction. The max forward regen current is adjustable from 100 amps up to the controller's full rated current.

If a load sensor is not used, this will be the single maximum regen current in the forward direction.

MAX REV REGEN

The **maximum reverse regen** parameter defines the maximum regenerative current at maximum load while traveling in the reverse direction. The max reverse regen current is adjustable from 100 amps up to the controller's full rated current.

If a load sensor is not used, this will be the single maximum regen current in the reverse direction.

If your application will have widely varying loads, we recommend that you include a load sensor (at Pin 1). The use of a load sensor can prevent unnecessarily harsh braking at light loads, which may lock up the wheels.

MIN FWD REGEN *[applicable only with optional load sensor]*

The **minimum forward regen** parameter defines the maximum regenerative current at minimum load while traveling in the forward direction. The Min Fwd Regen current is adjustable from 25 amps up to the controller's full rated current. The forward regen current increases linearly from Min Fwd Regen to Max Fwd Regen as the load sensor input varies from Min Load Volts to Max Load Volts.

Note: If the load sensor's voltage is out of range (less than 0.2 V or greater than 4.8 V) during interlock braking while the vehicle is driving forward, the regen current will default to the programmed Max Fwd Regen value.

MIN REV REGEN *[applicable only with optional load sensor]*

The **minimum reverse regen** parameter defines the maximum regenerative current at minimum load while traveling in the reverse direction. The Min Rev Regen current is adjustable from 25 amps up to the controller's full rated current. The reverse regen current increases linearly from Min Rev Regen to Max Rev Regen as the load sensor input varies from Min Load Volts to Max Load Volts.

Note: If the load sensor's voltage is out of range (less than 0.2 V or greater than 4.8 V) during interlock braking while the vehicle is driving in reverse, the regen current will default to the programmed Max Rev Regen value.

MAX LOAD VOLTS *[applicable only with optional load sensor]*

The **maximum load volts** parameter defines the load sensor input voltage at the maximum load. It is adjustable from 0.2 V to 4.8 V.

MIN LOAD VOLTS *[applicable only with optional load sensor]*

The **minimum load volts** parameter defines the load sensor input voltage at the minimum load. It is adjustable from 0.2 V up to the programmed Max Load Volts.

Electromagnetic Brake Parameters

The four Electromagnetic Brake parameters—along with the sequencing delay—affect the behavior of the auxiliary driver at Pin 8. This driver is typically used for an electromagnetic brake, as shown in the basic wiring diagram (Figure 3, page 7). See Figure 14 for an illustration of the relationship between interlock braking, the EM brake, and the sequencing, auxiliary, and interlock braking delays.

AUX TYPE

The **auxiliary driver type** parameter configures the low side driver at Pin 8. The auxiliary driver can be programmed to operate in any of the configurations (i.e., Types 1 through 5) described in Table 3. Types 1 through 4 are various ways of configuring the driver for an electromagnetic brake; Type 5 is a non-EM-brake option. If no auxiliary device will be connected to Pin 8, the auxiliary driver should be programmed to Type 0.

EM BRAKE PWM

The auxiliary driver output (at Pin 8) can be modulated if you are using an EM brake (or other auxiliary device) whose coil voltage rating is lower than the battery voltage. If the **electromagnetic brake PWM** parameter is programmed On, the brake will pull in at 100% PWM (full current up to 3 amps) for 500 ms and then pull back to 62.5% PWM (\approx 2 amps max) at a frequency of about 250 Hz and continue at this level until released. If programmed Off, the auxiliary driver output will remain steadily at 100% PWM.

AUX DELAY

The **auxiliary driver delay** parameter allows a delay before the electromagnetic brake is engaged (Pin 8 driver opened) after the vehicle reaches the neutral state (throttle in neutral, both direction switches open, motor speed approximately zero). The Aux Delay is adjustable from 0 to 30 seconds. When set to zero, there is no delay and the brake is engaged as soon as the vehicle reaches the neutral state. This parameter does not apply to Aux Type 1 (see Table 3).

For Aux Type 5, the device connected to Pin 8 will be off when the Pin 8 driver is open, and on when the driver is closed. The aux delay could be used to allow the auxiliary device to keep running for a short while after the vehicle reaches the neutral state.

INT BRAKE DLY

The **interlock brake delay** parameter allows a delay before the electromagnetic brake is engaged after the interlock switch opens; during this time, interlock braking is in effect. The electromagnetic brake is engaged when the delay has

Fig. 14 The electromagnetic brake parameters, in the context of the 1243GEN2 controller's four delay parameters (sequencing, interlock brake, main contactor open, and aux delays). This figure assumes the standard wiring configuration, which includes an EM brake.

For descriptions of the sequencing delay and main contactor open delay, see pages 42 and 40.

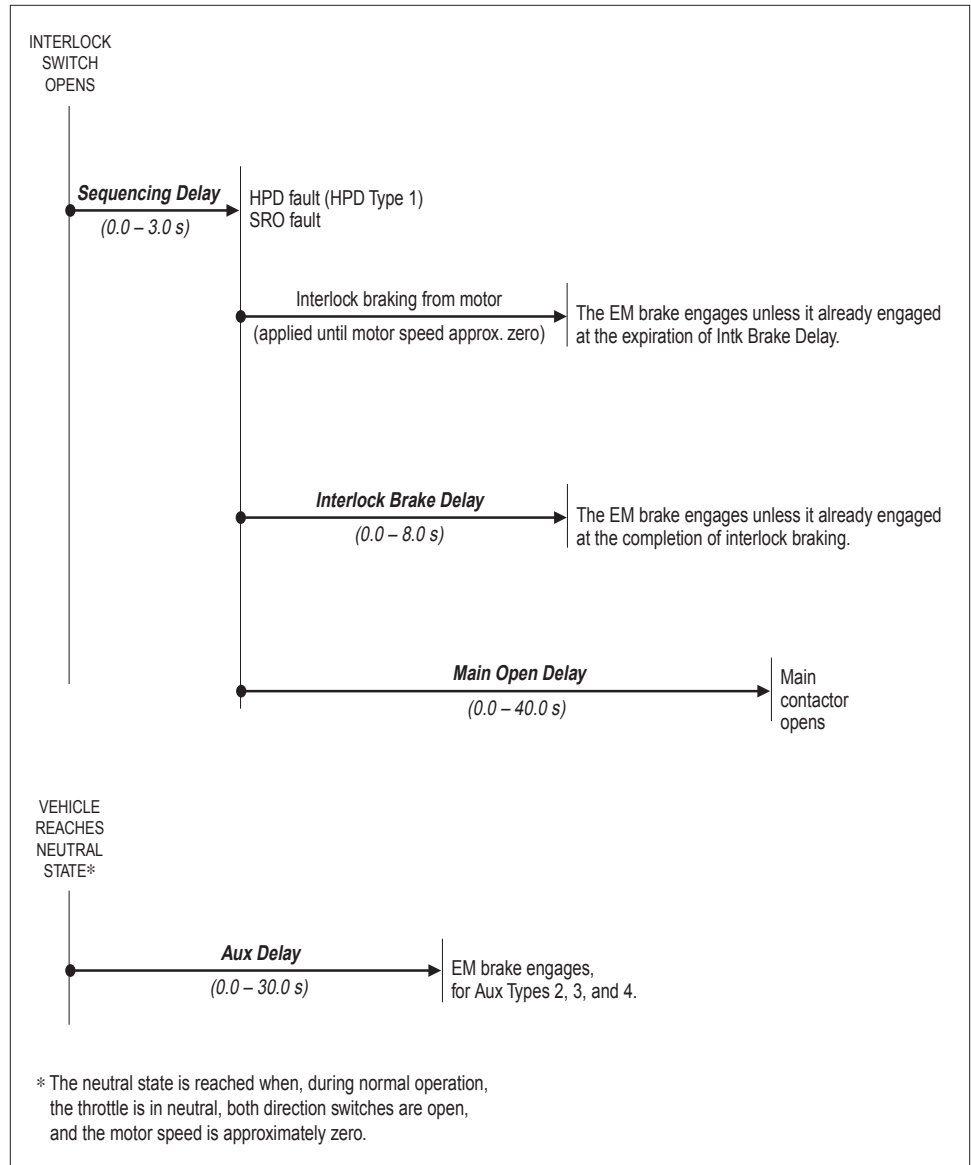

expired or when the motor speed approaches zero, whichever occurs first. The Interlock Brake Delay is adjustable from 0.0 to 8.0 seconds. When set to zero, there is no delay and the brake is engaged as soon as the interlock switch opens. Interlock braking will still occur until the motor speed hits zero.

For Aux Type 5, the interlock braking delay does not apply.

**Table 3 CONFIGURATION OPTIONS:
AUXILIARY DRIVER (Pin 8)**

TYPE	DESCRIPTION OF OPERATION
0	Aux driver disabled.
1	<p>Electromagnetic brake used like a parking brake.</p> <ul style="list-style-type: none"> • The brake is released when the interlock switch closes. • The brake is engaged as follows: <p><i>Interlock</i> The aux driver engages the brake when the interlock switch opens and (a) the programmed Sequencing Delay and Interlock Brake Delay expire or (b) the motor speed nears zero, whichever happens first.</p> <p><i>Neutral State</i> * The aux driver does not respond to neutral state; there is no therefore no Aux Delay.</p> <p><i>Emerg. Rev.</i> The aux driver does not respond to emergency reverse.</p>
2	<p>Electromagnetic brake used to prevent rolling when stopping on a hill.</p> <ul style="list-style-type: none"> • The brake is released when the interlock switch closes <u>and</u> either a direction switch or the emergency reverse switch closes. • The brake is engaged as follows: <p><i>Interlock</i> Same as Type 1.</p> <p><i>Neutral State</i> * When the vehicle reaches the neutral state, the aux driver engages the brake as soon as the programmed Aux Delay expires.</p> <p><i>Emerg. Rev.</i> After the emergency reverse switch has been applied and released, the aux driver engages the brake as soon as the programmed Aux Delay has expired. The Aux Delay timer starts when motor speed nears zero.</p>
3	<p>Electromagnetic brake functions as in <u>Type 2</u> except during Emerg. Rev.</p> <p><i>Emerg. Rev.</i> (a) If both direction switches are open when the emergency reverse switch is released, same as Type 2. (b) If a direction switch is closed when the emergency reverse switch is released, the Aux Delay timer starts when the emergency reverse switch is released.</p>
4	<p>Electromagnetic brake functions as in <u>Type 1</u> except during Emerg. Rev.</p> <p><i>Emerg. Rev.</i> Same as Type 3, except in situation (a), where the aux driver does not respond, and the brake therefore remains released.</p>
5	<p>Auxiliary device other than an electromagnetic brake.</p> <p>This option is appropriate if the aux driver will be used for a brush or pump motor contactor, for example, or for hydraulic steering assist. The aux driver will be energized when the interlock switch and either a direction switch or the emergency reverse switch are closed. The aux driver will turn off when the programmed Aux Delay has expired after the interlock switch opens, or both direction switches are opened while the vehicle is driving, or the emergency reverse switch is released. The Aux Delay timer starts when motor speed nears zero.</p>
<p>* The neutral state is reached when, during normal operation, the throttle is in neutral, no direction is selected (both direction switches open), and motor speed is approximately zero.</p>	

Speed Parameters

M1–M4, MAX FWD SPD

The **maximum forward speed** parameter defines the maximum controller voltage output at full throttle, in the forward direction. The maximum forward speed parameter is adjustable from the programmed creep speed up to 100%. It is tuned as part of the vehicle performance adjustment process (Section 5).

M1–M4, MAX REV SPD

The **maximum reverse speed** parameter defines the maximum controller voltage output at full throttle, in the reverse direction. The maximum reverse speed parameter is adjustable from 0% to 100%. It is tuned as part of the vehicle performance adjustment process (Section 5).

CREEP SPEED

The **creep speed** parameter defines the initial controller output generated when a direction is first selected. No applied throttle is necessary for the vehicle to enter the creep mode, only a direction signal. The controller maintains creep speed until the throttle is rotated out of the throttle deadband (typically 10% of throttle).

Creep speed is adjustable from 0% to 25% of the controller output; it cannot be set higher than the lowest programmed M1–M4 maximum forward speed. The specified creep speed is not displayed as the throttle percent in the programmer's Test Menu when a direction is selected and zero throttle is applied; only the 0% throttle command is displayed.

LOAD COMP

The **load compensation** parameter actively adjusts the applied motor voltage as a function of motor load current. This results in more constant vehicle speeds over variations in driving surface (ramps, rough terrain, etc.) without the vehicle operator constantly adjusting the throttle position; it also helps equalize loaded and unloaded vehicle speeds. The load compensation parameter is adjustable from 0% to 25% of the controller's PWM output. High values will cause the controller to be more aggressive in attempting to maintain vehicle speed. However, too much load compensation can result in jerky vehicle starts and speed oscillation ("hunting") when the vehicle is unloaded.

The load compensation parameter is tuned as part of the vehicle performance adjustment process (Section 5).

Throttle Parameters

THROTTLE TYPE

The 1243^{GEN2} controller accepts a variety of throttle inputs. Instructions are provided in Section 2 for wiring the most commonly used throttles: 5k Ω –0 and 0–5k Ω 2-wire potentiometers, 3-wire potentiometers, 0–5V throttles, current sources, and the Curtis ET-XXX electronic throttle.

The **throttle type** parameter can be programmed to 1, 2, 3, or 4. The standard throttle input signal type options are listed in Table 4.

THROTTLE TYPE	DESCRIPTION
1	2-wire 5k Ω –0 potentiometer
2	<i>single-ended</i> 3-wire potentiometer with 1k Ω to 10k Ω range; 0–5V voltage source; current source driving external resistor; or Curtis ET-XXX electronic throttle
3	2-wire 0–5k Ω potentiometer
4	<i>wigwag</i> 3-wire potentiometer with 1k Ω to 10k Ω range; 0–5V voltage source; or current source driving external resistor

THROTTLE DB

The **throttle deadband** parameter defines the throttle pot wiper voltage range that the controller interprets as neutral. Increasing the throttle deadband setting increases the neutral range. This parameter is especially useful with throttle assemblies that do not reliably return to a well-defined neutral point, because it allows the deadband to be defined wide enough to ensure that the controller goes into neutral when the throttle mechanism is released.

Examples of deadband settings (0%, 10%, 40%) are shown in Figure 15 for the four throttle types (see Table 4). In all the examples in Figure 15, the throttle max parameter is set at 100%.

The throttle deadband parameter is adjustable from 0% to 40% of the nominal throttle wiper range; the default setting is 10%. The nominal throttle wiper voltage range depends on the throttle type selected. See Table 1 (page 9) for the characteristics of your selected throttle type.

The throttle deadband is tuned as part of the vehicle performance adjustment process (Section 5).

Fig. 15 Effect of adjusting the Throttle Deadband parameter.

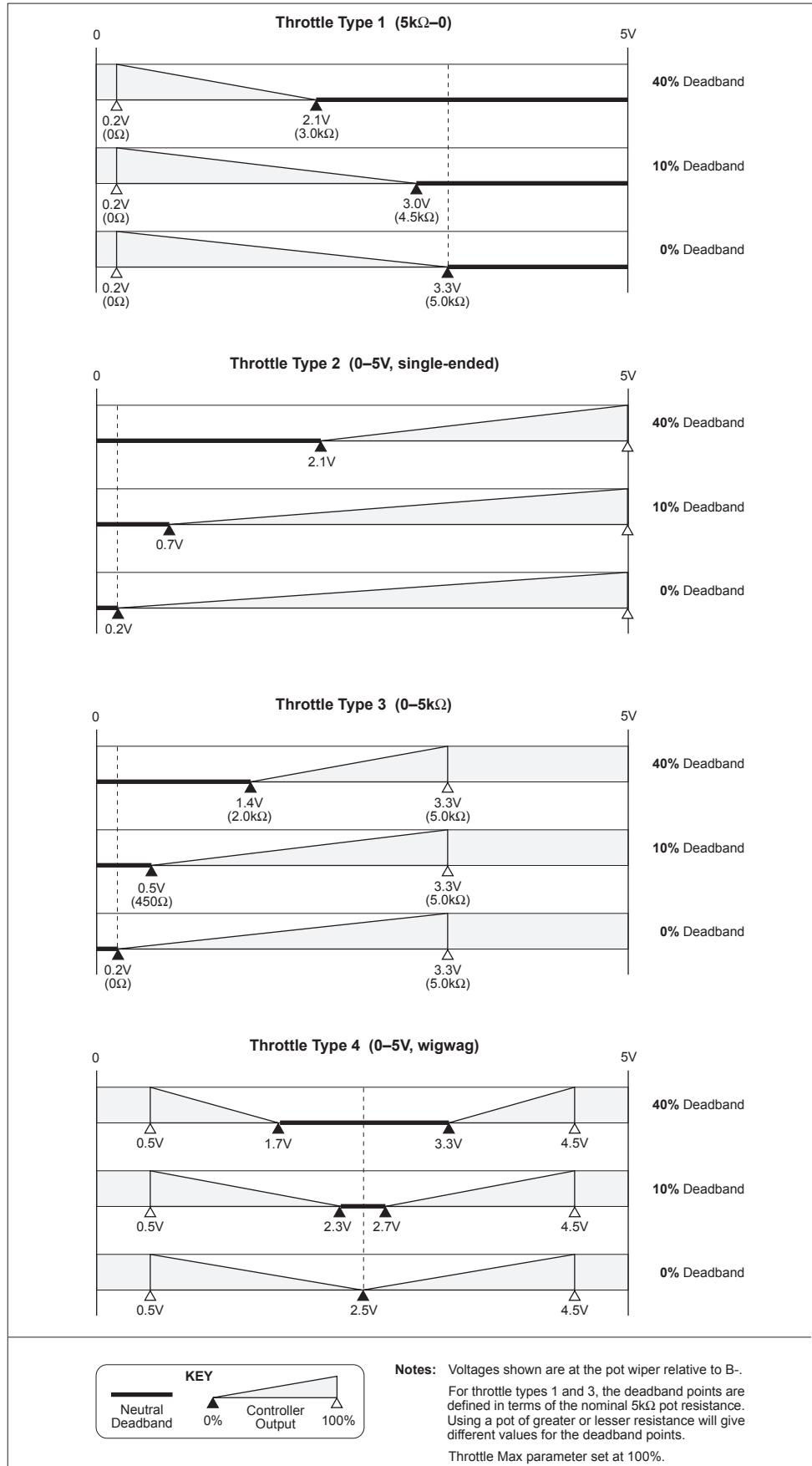

THROTTLE MAX

The **throttle max** parameter sets the wiper voltage or resistance required to produce 100% controller output. Decreasing the throttle max setting reduces the wiper voltage or resistance and therefore the full stroke necessary to produce full controller output. This feature allows reduced-range throttle assemblies to be accommodated.

The examples in Figure 16 illustrate the effect of three different throttle max settings (100%, 90%, 60%) on the full-stroke wiper voltage or resistance required to attain 100% controller output for the four throttle types.

The programmer displays the throttle max parameter as a percentage of the active throttle range. The active throttle range is not affected by the throttle deadband setting. The throttle max parameter can be adjusted from 100% to 60%; the default setting is 90%. The nominal throttle wiper range depends of the throttle type selected. See Table 1 (page 9) for the characteristics of your selected throttle type.

The throttle max parameter is tuned as part of the vehicle performance adjustment process (Section 5).

Fig. 16 *Effect of adjusting the Throttle Max parameter (throttle types 1 and 2).*

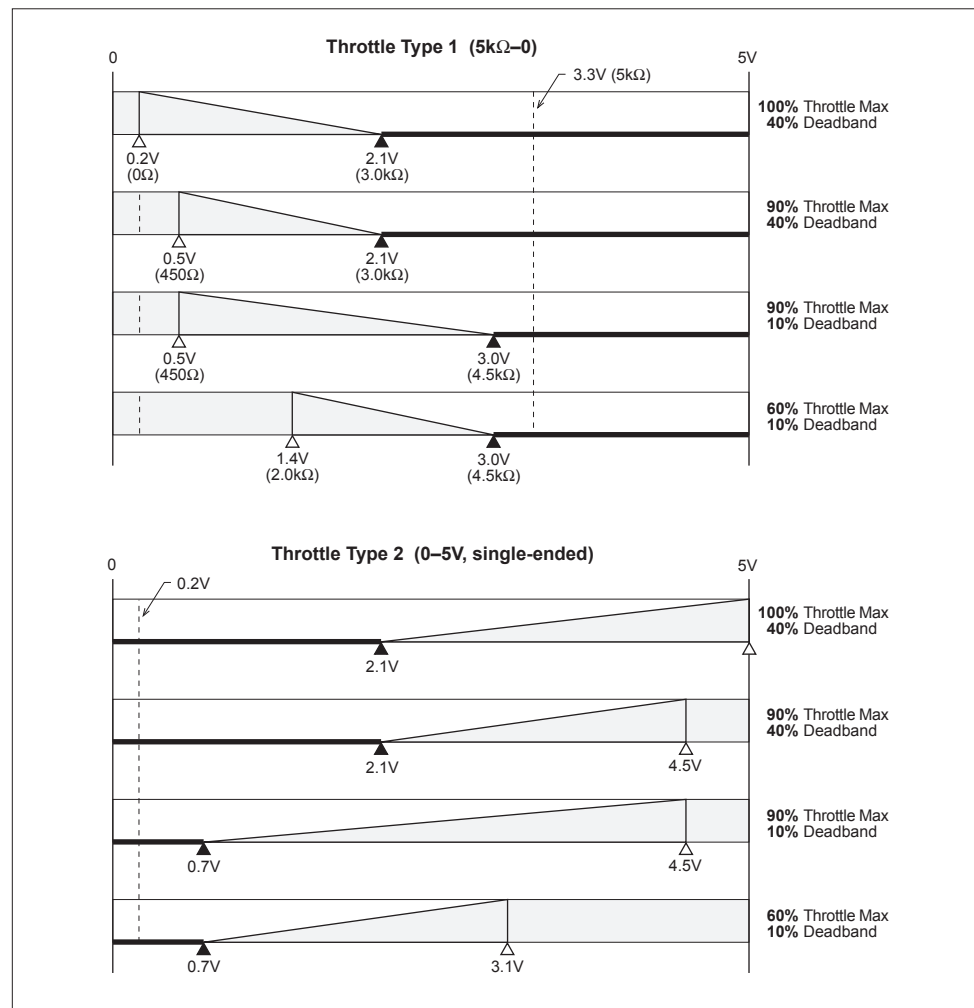
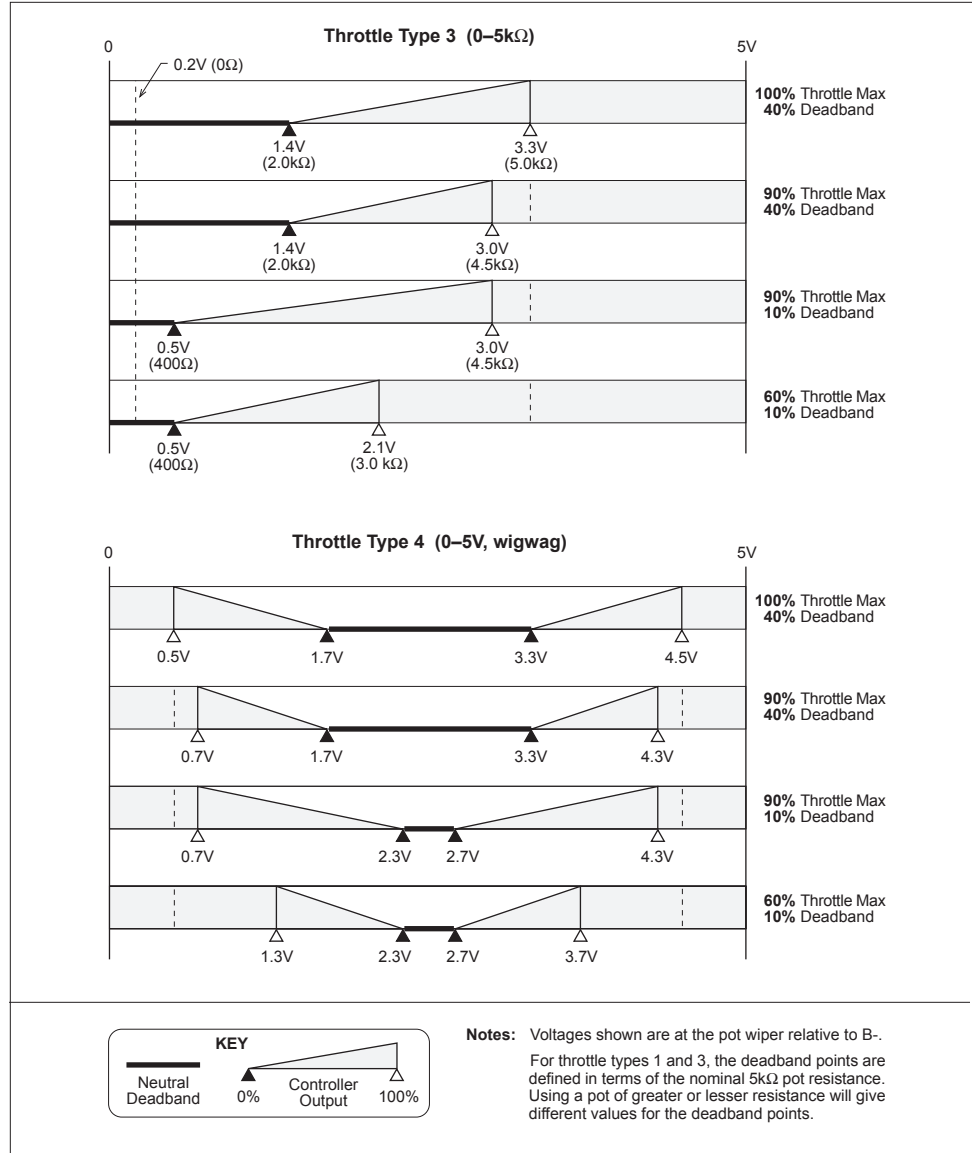

Fig. 16, cont.
Effect of adjusting the Throttle Max parameter (throttle types 3 and 4).



THROTTLE MAP

The **throttle map** parameter modifies the vehicle's response to the throttle input. The throttle map parameter's default setting of 50% provides a linear output response to throttle position. Values below 50% reduce the controller output at low throttle, providing enhanced slow speed maneuverability. Values above 50% give the vehicle a faster, more responsive feel at low throttle.

The throttle map setting can be programmed between 20% and 80%. The setting refers to the PWM output at half throttle, as a percentage of the throttle's full active range. The throttle's active range is the voltage or resistance between the 0% modulation point (the throttle deadband threshold) and the 100% modulation point (the throttle max threshold).

With creep speed set at 0 and maximum speed set 100%, a 50% throttle map setting will give 50% output at half throttle. A throttle map setting of 80% will give 80% output at half throttle. Six throttle map profiles (20, 30, 40, 50, 60, and 80%) are shown in Figure 17; in all these examples the creep speed is set at 0 and the maximum speed at 100%.

Fig. 17 *Throttle maps for controller with maximum speed set at 100% and creep speed set at 0.*

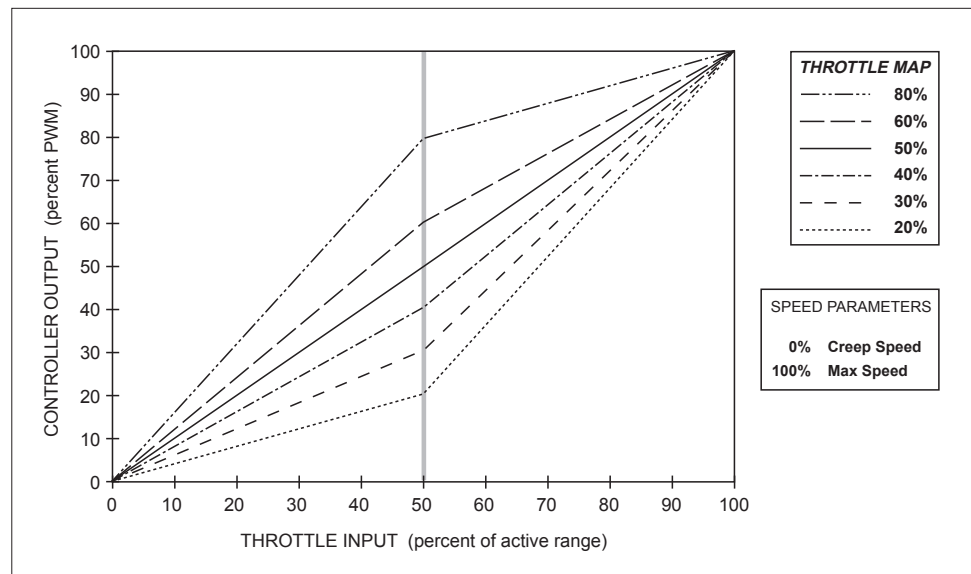

Changing either of the speed parameters changes the characteristics of the controller output relative to the throttle input and hence the throttle response. Controller output is always a percentage of the range defined by the speed parameters (the range between the creep speed and maximum speed settings). This means that controller output will begin to increase above the set creep speed as soon as the throttle exceeds the neutral deadband threshold. Controller output will continue to increase as the throttle input increases and will reach maximum output when the throttle input reaches the throttle max threshold. The maximum controller output at this point is defined by the value of the maximum speed parameter.

Increasing the creep speed value adds to the applied throttle and simply shifts the curves up. As shown in Figure 18, a creep speed setting of 10% with the Throttle Map set at 50% gives 60% PWM output (50% + 10%) at half throttle.

Fig. 18 Throttle maps for controller with maximum speed set at 100% and creep speed set at 10%.

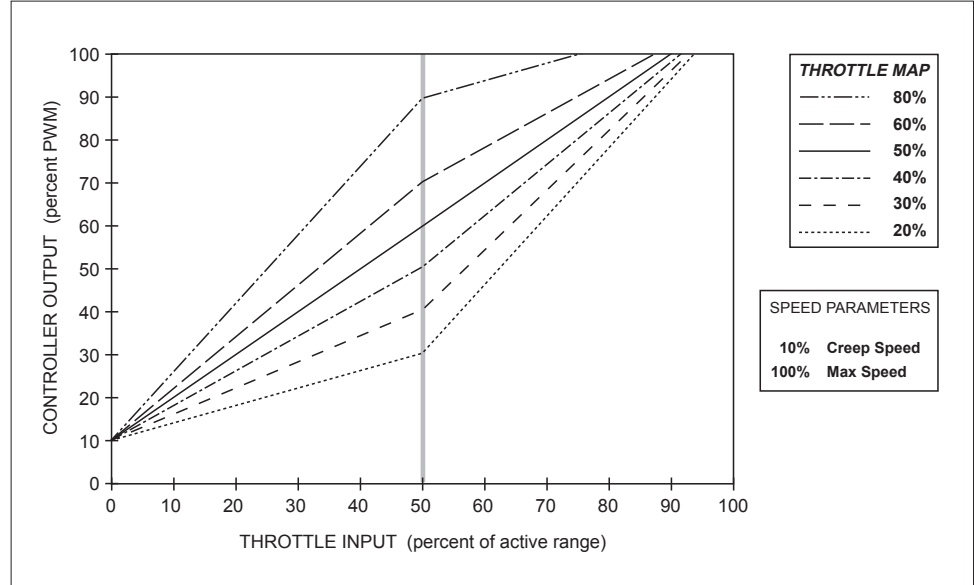

Reducing the max speed setting clips off the top of the throttle map. Figure 19 shows throttle map curves with the same 10% creep speed setting and the maximum speed setting dropped to 90%. The curves in this example are exactly as in Figure 18, except the PWM output hits a ceiling at 90%.

Fig. 19 Throttle maps for controller with maximum speed set at 90% and creep speed set at 10%.

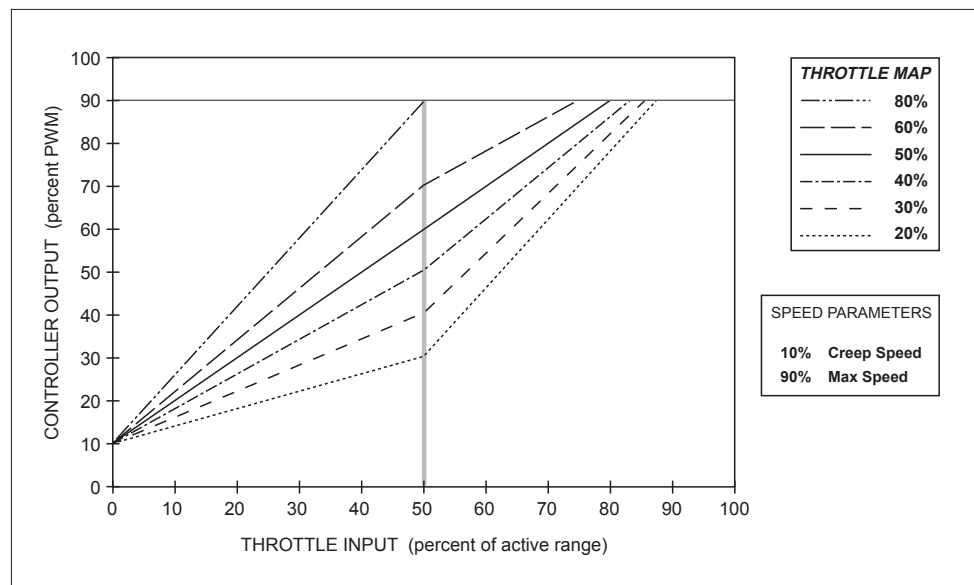

The throttle map is tuned as part of the vehicle performance adjustment process (Section 5).

POT LOW FAULT

The **pot low fault** parameter allows the controller's pot low fault detection to be disabled. This is useful when single-wire, ground (B-) referenced voltage throttle inputs are used. Setting the pot low fault parameter to Off disables the fault detection at the pot low input (Pin 7). It is recommended that the pot low fault parameter be set to On in any application where a resistive throttle is used. This will provide the most comprehensive throttle fault detection and provide the safest possible vehicle operation.

Note: The programmer's display name for the pot low fault is "Throttle Wiper Lo."

Field Parameters

FIELD MIN

The **minimum field current limit** parameter defines the minimum allowed field current, thus determining the vehicle's maximum speed. Field Min can be adjusted from 1.6 amps up to the lowest programmed M1–M4 Restraint value.

The Field Min parameter is tuned as part of the vehicle performance adjustment process (Section 5).

FIELD MAX

The **maximum field current limit** parameter defines the maximum allowed field current. The maximum field current limit setting determines the vehicle's maximum torque and the maximum power that the field winding will have to dissipate. Field Max can be adjusted from the programmed Field Min value up to the controller's full rated field current. (The full rated field current depends on the controller model; see specifications in Table D-1).

The Field Max parameter is tuned as part of the vehicle performance adjustment process (Section 5).

FLD MAP START

The **field map start** parameter defines the armature current at which the field map starts to increase from the programmed Field Min value. This parameter is adjustable from 25 amps up to the full rated armature current value. (The full rated armature current depends on the controller model; see specifications in Table D-1).

The field map start parameter is used to equalize the vehicle's maximum speed when loaded and unloaded. Increasing the field map start parameter value will increase the maximum load weight that the vehicle can carry while maintaining maximum speed on a level surface.

The field map start parameter is tuned as part of the vehicle performance adjustment process (Section 5).

FIELD MAP

The field map defines the relationship between armature current and field current under steady-state drive conditions. The shape of the field map is determined by the programmed Field Min, Field Max, Field Map, Field Map Start, and M1-M4 Drive C/L settings.

As shown in Figure 20, the field map parameter adjusts the field current at the Field Map Midpoint, which is located halfway between the programmed Field Map Start and the programmed M1-M4 Drive C/L. With the **field map** parameter set at 50%, the motor's field current increases linearly with increasing armature current—thus emulating a series wound motor.

Fig. 20 Field current relative to armature current, with field map parameter set at 50% and 20%.

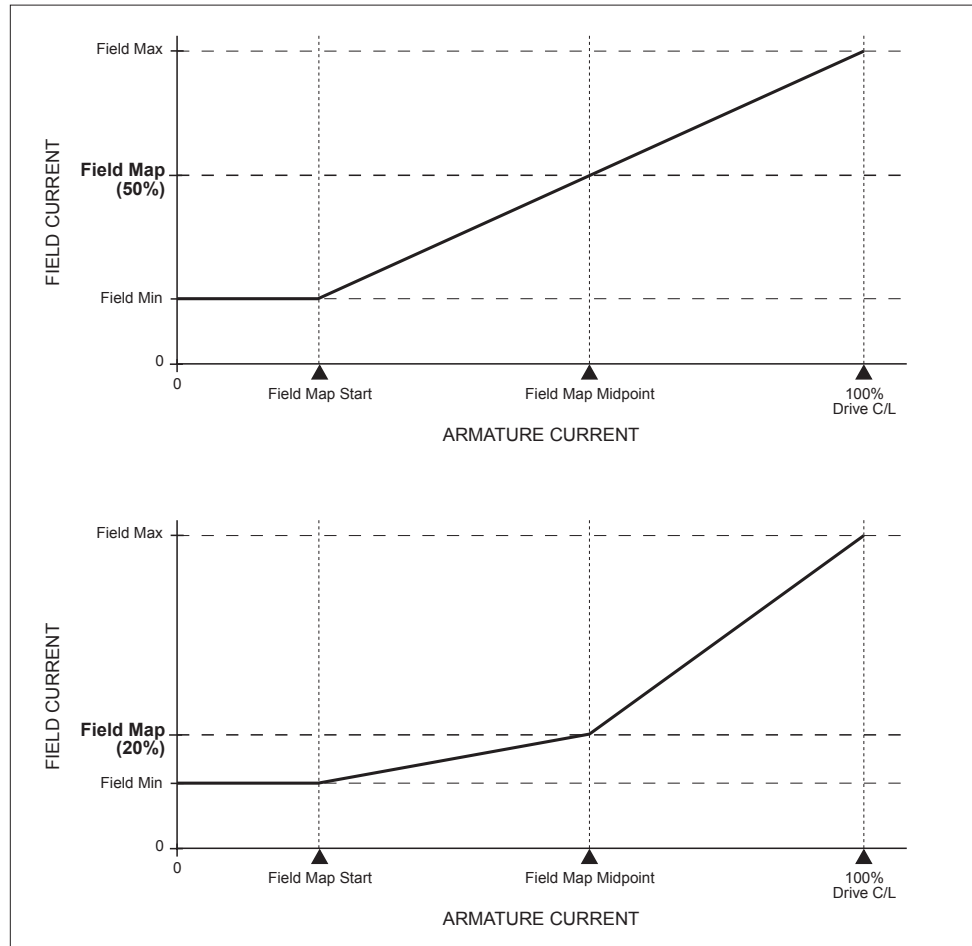

Decreasing the field map parameter reduces the field current at a given armature current. As the field current is reduced, the motor will be able to maintain speeds closer to the maximum speed value as its load increases; however, the motor's capability to produce torque at these higher speeds will decrease. With the Field Map reduced to 20%, the field current at the Field Map Midpoint will exceed Field Min by 20% of the range between Field Min and Field Max.

The field map parameter is tuned as part of the vehicle performance adjustment process (Section 5).

FIELD CHECK

The **field check** parameter determines whether the field diagnostics will be active. When programmed On, the controller checks for field open and field shorted faults. This parameter is typically programmed On except in series motor applications, or where the motor resistance is too high to provide valid fault data.

Main Contactor Parameters

MAIN CONT INTR

The **main contactor interlock** parameter allows the OEM to define a dual switch requirement to operate the vehicle. When this parameter is programmed On, the controller requires that both KSI (Pin 16) and the interlock input (Pin 15) be pulled high (to B+) before the controller will engage the main contactor. The main contactor will open after the interlock switch is opened and the sequencing delay expires. If this parameter is programmed Off, only the KSI input is required for the main contactor to be engaged.

After changing the main contactor interlock setting, KSI must be cycled for the new setting to take effect.

MAIN OPEN DLY

The **main contactor open delay** parameter is applicable only if the main contactor driver interlock has been programmed On. The delay can then be set to allow the contactor to remain engaged for a period of time after the interlock switch is opened. The delay is useful for preventing unnecessary cycling of the contactor and for maintaining power to auxiliary functions, such as a steering pump motor, that may be used for a short time after the interlock switch has opened. The main contactor open delay is programmable from 0 to 40 seconds.

After the interlock switch is opened, the programmed sequencing delay must expire before the main contactor open delay timer starts counting. Therefore, the time between the interlock switch opening and the main contactor disengaging is the sum of the sequencing delay and the main contactor open delay (see Figure 14, page 29.)

CONT DIAG

The **main contactor diagnostics** parameter, when programmed On, enables two checks to verify that the main contactor is present and that it has not welded closed. Each time the main contactor is commanded to engage, the controller first performs a main contactor welded test to verify that it is not already closed. The controller then engages the contactor and performs a missing contactor test to confirm that the contactor successfully engaged.

These checks are not performed if the main contactor diagnostics parameter is programmed Off. The main contactor driver, however, is always protected from overcurrents, short circuits, and overheating.

Sequencing Fault Parameters

ANTI-TIEDOWN

The **anti-tiedown** feature prevents operators from taping or “tying down” the mode select switches in order to operate permanently in Mode 2 or Mode 4 (which are typically the higher speed modes). Each time the interlock switch closes, the anti-tiedown feature checks which mode is selected. If the mode select switches are requesting Mode 2 or Mode 4 (Mode Select 1 switch closed), the controller will default to Mode 1 or Mode 3, depending on the position of the Mode Select 2 switch, and an anti-tiedown fault will be declared. The controller will then remain in Mode 1 or Mode 3 until the Mode Select 1 switch is released and reactivated. The anti-tiedown feature can be programmed On or Off.

HPD

The **high pedal disable (HPD)** feature prevents the vehicle from driving if greater than 25% throttle is already applied upon startup. In addition to providing routine smooth starts, HPD also prevents accidental sudden starts if problems in the throttle linkage (e.g., bent parts, broken return spring) give a throttle input signal to the controller even with the throttle released.

HPD requires the controller to receive a KSI input and an interlock input (HPD Type 1)—or simply a KSI input (HPD Type 2)—before receiving a throttle input greater than 25%; if the inputs are not received in the proper sequence, the controller will inhibit output to the motor. An HPD fault can be cleared by reducing the throttle demand to less than 25%.

HPD fault detection can be turned off by setting the HPD Type to 0. To meet EEC requirements, HPD must be programmed to Type 1 or Type 2.

Note: The conditions for HPD faults are not affected by whether the main contactor interlock parameter is On or Off.

HPD Type 0: No HPD fault detection

HPD Type 1: KSI+interlock

To drive the vehicle, the controller must receive both a KSI input and an interlock input before receiving a >25% throttle input. Any other sequence will result in an HPD fault that will prevent the vehicle from being driven.

With HPD Type 1, the sequencing delay parameter can be used to prevent HPD faults that would otherwise occur from momentary opening of the interlock switch while driving (see Figure 14, page 29). If the interlock switch is opened and then quickly closed before the programmed sequencing delay elapses, no HPD fault will be declared and operation will not be interrupted.

HPD Type 2: KSI only

To drive the vehicle, the controller must receive a KSI input before receiving a throttle input greater than 25%. Violation of this sequence will result in an HPD fault that will prevent the vehicle from being driven. With HPD Type 2, if

throttle is applied after the KSI input has been received but before the interlock switch is closed, the vehicle will accelerate to the requested speed as soon as the interlock switch is closed.

SRO

The **static return to off (SRO)** feature prevents the vehicle from being started when “in gear,” i.e., with a direction already selected. SRO checks the sequencing of the KSI and interlock inputs relative to a direction input. SRO faults can result from using an incorrect sequence, or from using a correct sequence with less than 50 msec between steps. If an SRO fault is declared, the controller will inhibit output to the motor until the fault is cleared by using an acceptable sequence.

The sequencing delay can be used to prevent SRO faults that would otherwise occur from momentary opening of the interlock switch while driving (see Figure 14, page 29). If the interlock switch is opened and then quickly closed before the programmed delay time elapses, no SRO fault will be declared and operation will not be interrupted.

Note: The conditions for SRO faults are not affected by whether the main contactor interlock parameter is On or Off.

Three types of SRO are available, along with a “no SRO” option.

SRO Type 0: No SRO fault detection

SRO Type 1: KSI and Interlock before direction input

To drive the vehicle, the controller must receive both a KSI input and an interlock input before receiving an input from either direction switch. The order in which the KSI and interlock inputs are received does not matter, only that they are both received before a direction input.

SRO Type 2: KSI before Interlock before direction input

To drive the vehicle, the controller must receive a KSI input and then an interlock input before receiving an input from either direction switch.

SRO Type 3: KSI before Interlock before forward input

Type 3 SRO is useful for walkie vehicles that frequently operate on ramps. To drive the vehicle in the forward direction, the controller must receive the KSI, interlock, and forward inputs in that order, as in SRO Type 2. However, this sequence is not required for operation in reverse. With SRO Type 3, a reverse input is allowed at any place in the sequence: i.e., before interlock, or even before KSI.

SEQUENCING DLY

The **sequencing delay** feature allows the interlock switch to be cycled within a set time—the sequencing delay—without activating HPD or SRO. This feature is useful in applications where the interlock switch may bounce or be

momentarily cycled during operation. However, it is important to bear in mind that the same sequencing delay also delays the initiation of interlock braking (see Figure 14, page 29).

The sequencing delay can be programmed from 0.0 to 3.0 seconds, with 0.0 corresponding to no delay.

Emergency Reverse Parameters



*The polarity of the **S1** and **S2** connections will affect the operation of the emergency reverse feature. The forward and reverse switches and the **S1** and **S2** connections must be configured so that the vehicle drives away from the operator when the emergency reverse button is pressed.*

EMR REV C/L

When emergency reverse is activated, the **emergency reverse current limit** parameter defines the maximum braking current during deceleration and the maximum drive current after the vehicle switches direction. The emergency reverse current limit is adjustable from 50 amps up to the controller's full rated braking current. (The full rated braking current depends on the controller model; see specifications in Table D-1).

EMR REV CHECK

The **emergency reverse check** parameter is applicable only when the emergency reverse feature is being used in the application. If emergency reverse is not being used, this parameter should be set to Off.

When enabled (programmed On), the emergency reverse check tests for continuity from the emergency reverse check output (Pin 10) to the emergency reverse input (Pin 13). Therefore, the emergency reverse wiring should be connected as closely as possible to the controller side of the emergency reverse switch. The recommended wiring is shown in the standard wiring diagram, Figure 3 (page 7).

EMR DIR INTR

In applications that use the emergency reverse feature, the **emergency reverse direction interlock** parameter defines the requirements for resuming normal operation after using emergency reverse. After emergency reverse has been used, the controller sets the output drive to zero regardless of whether a direction or throttle is being requested. With the emergency reverse direction interlock parameter set to On, the operator can either open both direction switches or cycle the interlock switch to enable normal operation. With the emergency reverse direction interlock parameter set to Off, the only way for the operator to resume normal operation is by cycling the interlock switch.

Motor Protection Parameters

The 1243_{GEN2} controller can protect the motor from damage due to overtemperature by cutting back the motor speed. An estimate of the motor temperature is derived from the resistance of the field winding. The controller measures field current, field PWM, and battery voltage, and uses these measurements to calculate the instantaneous field resistance. This value is filtered and compared to two setpoints: Motor Warm Resistance and Motor Hot Resistance. If the field resistance reaches the Motor Warm Resistance setpoint, the motor maximum speed will be limited to the programmed Warm Speed. If the field resistance reaches the Motor Hot Resistance setpoint, the controller will no longer drive but all braking functions will remain active. If this motor protection feature is not desired, it can be disabled by programming the motor resistance compensation parameter Off.

WARM SPEED

The **warm speed** parameter defines the maximum drive speed output when the motor field resistance is at or above the Motor Warm Resistance setpoint. The warm speed is adjustable from 0 to 100% of drive output.

MOT WRM x10 mΩ

The **motor warm resistance** parameter defines the field resistance setpoint at which a motor warm fault will occur and the maximum speed will be controlled by the Warm Speed setting.

Note: The parameter value is in ten-milliohm units. If you want to program the Motor Warm Resistance setpoint to 900 mΩ (0.9 Ω), you would enter 90 for the MOT WRM x10 mΩ value. The Motor Warm Resistance setpoint is adjustable from 100 mΩ (MOT WRM x10 mΩ =10) up to the Motor Hot Resistance setpoint.

MOT HOT x10 mΩ

The **motor hot resistance** parameter defines the field resistance setpoint at which a motor hot fault will occur and no drive output will be allowed. It is adjustable from the Motor Warm Resistance setpoint up to 2500 mΩ (2.5 Ω). The value entered is in ten-milliohm units, which means the maximum Motor Hot Resistance value is one-tenth of 2500 (i.e., MOT HOT x10 mΩ =250).

MOT Ω COMP

The **motor resistance compensation** parameter is used (programmed On) to enable the motor overtemperature protection feature.

Hourmeter Parameters

Two individual hourmeters are built into the 1243_{GEN2} controller, each with non-volatile memory:

- a total hourmeter, that measures the total operating time (KSI on-time), and
- a traction hourmeter, that measures the time that a direction is selected.

Each hourmeter has a corresponding service timer and disable timer. Hourmeter information is viewable via the programmer or the Spyglass display.

For each hourmeter, the service timer is used to set the time before scheduled maintenance is due. When the set service time expires, the service warning fault occurs and the disable timer starts. If the programmed disable time expires before the scheduled maintenance is performed, the controller defaults to the programmed traction fault speed.

Hourmeter “Preset” Settings

The 1243_{GEN2} controller is shipped from the factory with each of its two hourmeters preset to 0. If the controller is being installed in a new vehicle, these presets do not need to be adjusted. If the controller is being installed in a “used” vehicle, however, it may be desirable to transfer the existing hourmeter values to the new controller. To do this, the existing hourmeter values must be entered as follows.

Each meter records time to 999999.9 hours (114 years), and will roll over to 000000.0 if this is exceeded. The adjust high, adjust middle, and adjust low parameters each set two of the digits on the meter: HHMMLL.

ADJ HOURS HIGH

The **adjust hours high** parameter is used to set the highest two digits, from 00 to 99.

ADJ HOURS MID

The **adjust hours middle** parameter is used to adjust the middle two digits, from 00 to 99.

ADJ HOURS LOW

The **adjust hours low** parameter is used to adjust the lowest two digits, from 00 to 99. It is not possible to set tenths.

SET TOTL HRS

The **set total hours** parameter is used to apply the preset high, middle, and low values to the total (i.e., KSI on-time) hourmeter. First, adjust the preset values as desired for the total hourmeter. Then, program the Set Total Hours parameter On, which automatically loads the preset values.

Once the preset values have been loaded, the Set Total Hours parameter should be programmed Off.

SET TRAC HRS

The **set traction hours** parameter is used to apply preset high, middle, and low values to the traction hourmeter. First, adjust the preset values as desired for the traction hourmeter. Then, program the Set Traction Hours parameter On, which automatically loads the preset values. Once they have been loaded, the Set Traction Hours parameter should be programmed Off.

Hourmeter Service Timer Setting

SRVC TOTL HRS

The **total service hours** parameter is used to set the timer for the next scheduled overall maintenance. The service interval can be up to 5,000 hours. The total service timer is adjustable between 0.0 and 50.0, in 0.5 increments, with 25.0 being equivalent to 2,500 hours (25.0×100).

Setting the parameter to 0 means that the timer will never expire—i.e., there will be no overall maintenance reminder.

SRVC TRAC HRS

The **traction service hours** parameter is used to set the timer for the next scheduled traction motor maintenance. The service interval can be up to 5,000 hours. The traction service timer is adjustable between 0.0 and 50.0, in 0.5 increments, with 25.0 being equivalent to 2,500 hours (25.0×100).

Setting the parameter to 0 means that the timer will never expire—i.e., there will be no motor maintenance reminder.

Hourmeter Disable Timer Setting

DIS TOTL HRS

The **total disable hours** parameter is used to set the total disable timer; it can be adjusted between 0 and 250 hours, in 1 hour increments. If the total disable timer expires, the traction fault speed goes into effect.

Setting the parameter to 0 means that the total disable timer will never expire and therefore never invoke the traction fault speed.

DIS TRAC HRS

The **traction disable hours** parameter is used to set the traction disable timer; it can be adjusted between 0 and 250 hours, in 1 hour increments. If the traction disable timer expires, the traction fault speed goes into effect.

Setting the parameter to 0 means that the traction disable timer will never expire and therefore never invoke the traction fault speed.

TRAC FAULT SPD

The **traction fault speed** parameter sets the maximum drive speed in the event the traction disable timer expires or the total disable timer expires; it can be adjusted between 0–100% of drive output, and applies to all modes.

Hourmeter Service Timer Resetting

The hourmeter service timers must be reset (programmed Off) after service is performed, using the Service Total and Service Traction parameters.

Occasionally, the vehicle may be brought in for servicing before its scheduled maintenance is due—for example, because of some specific problem. You might want to check the service timers at this time to see how many hours they have accumulated. If routine maintenances is due shortly, you could perform it now instead, and reset the appropriate service timer—thus avoiding an extra trip to the shop.

SERVICE TOTL

When the total service timer expires, the controller automatically sets the **service total** parameter On. The Service Total parameter must then be programmed Off to indicate the appropriate service has been performed.

If a vehicle is brought in for service before a service warning is issued, you can check the accumulated total service hours. Plug in the 1311 programmer and go to the Monitor menu. Multiply the “Tot Srvc X25” value by 25 and add the “+Tot Srvc” value; this is how many total hours have elapsed since the total service timer was last reset.

When service is performed before the total service timer expires, the Service Total parameter must be programmed On and then Off to reset it.

SERVICE TRAC

When the traction service timer expires, the controller automatically sets the **service traction** parameter On. The Service Traction parameter must then be programmed Off to indicate the appropriate service has been performed.

If a vehicle is brought in for service before a service warning is issued, you can check the accumulated traction service hours. Plug in the 1311 programmer and go to the Monitor menu. Multiply the “Trac Srvc X25” value by 25 and add the “+Trac Srvc” value; this is how many traction hours have elapsed since the traction service timer was last reset.

When service is performed before the traction service timer expires, the Service Traction parameter must be programmed On and then Off to reset it.

Other Hourmeter Parameters

HOURLMETER TYPE

The Spyglass gauge displays hourmeter data for 5 seconds each time the keyswitch is turned on. The **hourmeter type** parameter defines whether the total hourmeter or traction hourmeter data will be displayed. When this parameter is programmed On, the total hourmeter is displayed; when programmed Off, the traction hourmeter is displayed.

PUMP METER

The **pump meter** parameter, when programmed On, configures the Fault Output 1 line (at Pin 2) to function as an input to measure the hours a pump is running. The pump is considered to be running when Pin 2 is at the battery voltage. When the pump meter parameter is programmed On, the traction hourmeter serves as a combination traction/pump hourmeter, and all the above “TRAC” hourmeter parameters apply to both traction hours and pump hours. The traction/pump hourmeter counts the hours when a direction is selected and the hours when the pump is running.

Battery Discharge Indicator (BDI) Parameters

The battery discharge indicator constantly calculates the battery state-of-charge whenever KSI is on. When KSI is turned off, the present battery state-of-charge is stored in non-volatile memory. BDI information is viewable via the Spyglass display and via the 1311 programmer's Monitor Menu as BDI%. Three parameters are used to adjust the display.

The standard values for flooded lead acid and sealed maintenance-free batteries are listed below.

	BATTERY TYPE	
	FLOODED	SEALED
Full volts (VPC)	2.04	2.04
Empty volts (VPC)	1.74	1.91
Reset volts (VPC)	2.10	2.10

Custom values can be entered based on specific batteries in consultation with a Curtis applications engineer.

Note: BDI values are set without the decimal point; 2.04 volts per cell, for example, will appear as 204 (i.e., VPC × 100) on the programmer. The Full, Empty, and Reset voltages are set in VPC units. For whole-battery voltages (rather than VPC values), see Table 5.

FULL VOLTS

The **full voltage** parameter sets the battery voltage that will be considered 100% state-of-charge. When a loaded battery drops below this voltage, it begins to lose charge. The full voltage value can be set from the programmed Empty Volts value up to the programmed Reset Volts value, in 0.01 VPC increments.

After adjusting Full Volts, KSI must be cycled for the new setting to take effect.

EMPTY VOLTS

The **empty voltage** parameter sets the battery voltage that will be considered 0% state-of-charge. When the battery remains under this voltage consistently, the BDI will read 0% state of charge. The empty voltage value can be set from 1.50 up to the programmed Full Volts value, in 0.01 VPC increments.

After adjusting Empty Volts, KSI must be cycled for the new setting to take effect.

RESET VOLTS

The **reset voltage** parameter sets the battery voltage used to detect the 100% state-of-charge point on a battery with no load. Whenever the programmed Reset Voltage is present for 2 seconds (except during regenerative braking), the

**Table 5 STANDARD BATTERY VOLTAGES
FOR FLOODED LEAD ACID AND SEALED MAINTENANCE-FREE BATTERIES**

PARAMETER	24V BATTERY		36V BATTERY	
	FLOODED	SEALED	FLOODED	SEALED
Full volts	24.5 V (2.04 × 12)	24.5 V (2.04 × 12)	36.7 V (2.04 × 18)	36.7 V (2.04 × 18)
Empty volts	20.9 V (1.74 × 12)	22.9 V (1.74 × 12)	31.3 V (1.91 × 18)	34.4 V (1.91 × 18)
Reset volts	25.2 V (2.10 × 12)	25.2 V (2.10 × 12)	37.8 V (2.10 × 18)	37.8 V (2.10 × 18)

Note: To convert VPC to the actual Full, Empty, or Reset voltage, multiply the VPC by 12 for 24V systems or by 18 for 36V systems.

BDI% will automatically reset to 100%. The reset voltage value can be set from the programmed Full Volts value up to 3.00 VPC, in 0.01 VPC increments.

BATTERY ADJUST

The **battery adjustment** parameter is used to adjust the BDI algorithm to compensate for battery capacity. Higher capacity batteries can spend more time below the Full Volts setting before beginning to lose charge. The battery adjustment parameter sets the number of seconds of droop required before the battery state of charge is decremented by 1%. It is adjustable from 0.1 to 20.0 seconds.

BDI DISABLE

The **BDI disable** parameter, when programmed On, limits the vehicle's maximum speed to the BDI Limit Speed when the battery state-of-charge is 0%.

BDI LIMIT SPEED

The **BDI limit speed** parameter sets the vehicle's maximum allowed speed when the BDI disable parameter is programmed On and the battery state of charge is 0%. The BDI limit speed is adjustable from 0 to 100% of drive output.

If the BDI disable parameter is programmed Off, the BDI limit speed will not be in effect.

Fault Code Parameters

FAULT CODE

The 1243^{GEN2} controller has two fault outputs, at Pins 2 and 3, which can be used to transmit signals to LEDs located on the display panel or on any remote panel. The fault outputs can be configured to display faults in two different formats: Fault Code format or Fault Category format. The **fault code** parameter is used to select the preferred format.

In Fault Code format (fault code parameter On), the two fault outputs operate independently. When a fault is present, the Fault 1 driver (Pin 2) provides a pulsed signal equivalent to the fault code flashed by the controller's built-in Status LED; the fault codes are listed in Table 8, page 74. The Fault 2 driver (Pin 3) will steadily pull low (to B-) when any fault is present, and can be used to drive a fault/no-fault LED. When no faults are present, the Fault 1 and Fault 2 outputs will both be high.

In Fault Category format (fault code parameter Off), each combination of the two fault outputs defines one of four fault categories. Table 6 lists the possible faults included in each category.

Note: Alternatively, Pin 2 can be used as a pump meter input, and Pin 3 can be used to interface an external auxiliary enable circuit; see fault output wiring, page 14.

FAULT CATEGORY	FAULT 1 OUTPUT	FAULT 2 OUTPUT	POSSIBLE EXISTING FAULTS
0	HIGH	HIGH	(no faults present)
1	LOW	HIGH	Current Shunt, HW Failsafe, M- Shorted, Throttle Wiper High or Low, Emergency Reverse Wiring Fault, Field Winding Open, Contactor Coil or Field Shorted, Main Contactor Welded or Missing
2	HIGH	LOW	Low Battery Voltage, Overvoltage, Thermal Cutback
3	LOW	LOW	Anti-Tiedown, HPD, SRO, Expired Service Timer or Disable Timer, Motor Too Hot

BDI LOCKOUT

When the **BDI lockout** parameter is programmed On, the Fault 2 output (at Pin 3) can be used as an interface to an external auxiliary enable circuit. When $BDI\% = 0$, the Fault 2 output will be high; when $BDI\% \geq 1$, the Fault 2 output will be low.

When BDI lockout is programmed Off, the Fault 2 output is determined by the setting of the Fault Code parameter.

CONTROLLER CLONING

Once a controller has been programmed to the desired settings, these settings can be transferred as a group to other controllers, thus creating a family of “clone” controllers with identical settings. Note: Cloning only works between controllers with the same model number and software version.

To perform cloning, plug the 1311 programmer into the controller that has the desired settings. Scroll down to the Functions menu; “Settings” is the only function included here. Select “Get settings from controller” to copy the settings into the programmer, then select “+” to save the settings or “-” to abort them.

Plug the programmer into the controller that you want to have these same settings, and select “Write settings to controller.”

4

INSTALLATION CHECKOUT

Before operating the vehicle, carefully complete the following checkout procedure. If you find a problem during the checkout, refer to the diagnostics and troubleshooting section (Section 7) for further information.

The installation checkout can be conducted with or without a programmer. The checkout procedure is easier with a programmer. Otherwise, observe the Status LED (located in the controller's label area) for diagnostic codes. The codes are listed in Section 7.



Put the vehicle up on blocks to get the drive wheels up off the ground before beginning these tests.

Do not stand, or allow anyone else to stand, directly in front of or behind the vehicle during the checkout.

Make sure the keyswitch is off, the throttle is in neutral, and the forward and reverse switches are open.

Wear safety glasses and use well-insulated tools.

1. If a programmer is available, connect it to the programmer connector.
2. Turn the keyswitch on. The programmer should power up with an initial display, and the controller's Status LED should begin steadily blinking a single flash. If neither happens, check for continuity in the keyswitch circuit and controller ground.
3. Select the System Faults menu. The display should indicate "No Known Faults." Close the interlock switch. To do this on a walkie, pull the tiller down to the operating position. The Status LED should continue blinking a single flash and the programmer should continue to indicate no faults.

If there is a problem, the LED will flash a diagnostic code and the programmer will display a diagnostic message. If you are conducting the checkout without a programmer, look up the LED diagnostic code in Section 7: Diagnostics and Troubleshooting.

When the problem has been corrected, it may be necessary to cycle the keyswitch in order to clear the fault.

4. With the interlock switch closed, select a direction and operate the throttle. The motor should begin to turn in the selected direction. If it does not, first verify the wiring to the forward and reverse switches. If the

switch wiring is correct, turn off the controller, disconnect the battery, and exchange the motor's field connections (**S1** and **S2**) on the controller. The motor should now turn in the proper direction.



The motor should run proportionally faster with increasing throttle. If not, refer to Section 7. **CAUTION:** The polarity of the **S1** and **S2** connections will affect the operation of the emergency reverse feature. The forward and reverse switches and the **S1** and **S2** connections must be configured so that the vehicle drives away from the operator when the emergency reverse button is pressed.

5. Select the Monitor menu, and scroll down to observe the status of the forward, reverse, interlock, emergency reverse, and mode switches. Cycle each switch in turn, observing the programmer. The programmer should display the correct status for each switch.
6. Verify that all options, such as high pedal disable (HPD), static return to off (SRO), and anti-tiedown are as desired.
7. On walkies, verify that the emergency reverse feature is working correctly (i.e., press the emergency reverse button, and confirm that the wheels turn in the proper direction to drive the vehicle away from the operator).

If you have the optional emergency reverse check wiring, verify the checking circuit. Apply throttle so that the drive wheel spins. While continuing to apply throttle, temporarily disconnect one of the emergency reverse wires. The drive wheel should come to a stop and a fault should be indicated. Be sure to reconnect the emergency reverse wire after completing this test of the checking circuit.

5

VEHICLE PERFORMANCE ADJUSTMENT

The 1243^{GEN2} controller is a very powerful vehicle control system. Its wide variety of adjustable parameters allow many aspects of vehicle performance to be optimized. This section provides explanations of what the major tuning parameters do and instructions on how to use these parameters to optimize the performance of your vehicle. Once a vehicle/motor/controller combination has been tuned, the parameter values can be made standard for that system or vehicle model. Any changes in the motor, the vehicle drive system, or the controller will require that the system be tuned again to provide optimum performance.

The tuning procedures should be conducted in the sequence given, because successive steps build upon the ones before. The tuning procedures instruct personnel how to adjust various programmable parameters to accomplish specific performance goals. It is important that the effect of these programmable parameters be understood in order to take full advantage of the controller's features. Please refer to the descriptions of the applicable parameters in Section 3 if there is any question about what any of them do.

The 1243^{GEN2}'s MultiMode™ feature allows the vehicle to be configured to provide four distinct operating modes. Typically Mode 1 is configured for slow precise indoor maneuvering, Mode 4 for faster, long distance, outdoor travel, and Modes 2 and 3 for application-specific special conditions. Some of the tuning procedures may need to be repeated four times, once for each mode.

MAJOR TUNING

Four major performance characteristics are usually tuned on a new vehicle:

- ① Tuning the Throttle's Active Range
- ② Tuning the Controller to the Motor
- ③ Setting the Vehicle's Unloaded Top Speed
- ④ Equalization of Loaded/Unloaded Vehicle Speed.

These four characteristics should be tuned in the order listed.

① Tuning the Throttle's Active Range

Before attempting to optimize any specific vehicle performance characteristics, it is important to ensure that the controller output is operating over its full range. The procedures that follow will establish Throttle Deadband and Throttle Max parameter values that correspond to the absolute full range of your particular throttle mechanism. It is advisable to allow some buffer around the absolute full range of the throttle mechanism to allow for throttle resistance variations over time and temperature as well as variations in the tolerance of potentiometer values between individual throttle mechanisms.

①-A *Tuning the Throttle Deadband*

- STEP 1. Jack the vehicle wheels up off the ground so that they spin freely.
- STEP 2. Plug the programmer into the controller and turn on the key-switch and interlock switch (if used).
- STEP 3. Select the Monitor Menu. The Throttle % field should be visible at the top of the display. You will need to reference the value displayed here. For convenience, set a bookmark here so you can return easily to read the Throttle % value.
- STEP 4. Scroll down until the Forward Input field is visible. The display should indicate that the forward switch is Off.
- STEP 5. Slowly rotate the throttle forward until the display indicates that the forward switch is On. Use care with this step as it is important to identify the threshold throttle position at which the forward switch is engaged and the controller recognizes the forward command.
- STEP 6. Without moving the throttle, return to the Throttle % field and read the value shown. This value should be zero. If the Throttle % value is zero, proceed to Step 7. If it is greater than zero, the Throttle Deadband parameter must be increased (go to the Program menu) and the procedure repeated from Step 5 until the Throttle % is zero at the forward direction engagement point. Setting a second bookmark at the Throttle Deadband parameter will allow you to toggle back and forth easily between the parameter and the Throttle % field.
- STEP 7. While observing the Throttle % value in the programmer's Test/Monitor Menu, continue to rotate the throttle past the forward switch engagement point. Note where the Throttle % value begins to increase, indicating that the controller has begun to supply drive power to the motor. If the throttle had to be rotated further than desired before the Throttle % value began to increase, the Throttle Deadband parameter value must be decreased and the procedure repeated from Step 5. If the amount of rotation between the point at which the forward switch is engaged and the Throttle % value begins to increase is acceptable, the Throttle Deadband is properly tuned.
- STEP 8. If a bidirectional (wigwag) throttle assembly is being used, the procedure should be repeated for the reverse direction. The Throttle Deadband value should be selected such that the throttle operates correctly in both forward and reverse.

①-B *Tuning the Throttle Max*

- STEP 1. Jack the vehicle wheels up off the ground so that they spin freely.
- STEP 2. Plug the programmer into the controller and turn on the key-switch and interlock switch (if used).
- STEP 3. Select the Monitor Menu. The Throttle % field should be visible at the top of the display. You will need to reference the value displayed here. For convenience, set a bookmark here so you can return easily to read the Throttle % value.
- STEP 4. Rotate the throttle forward to its maximum speed position and observe the Throttle % value. This value should be 100%. If it is less than 100%, the Throttle Max parameter value must be decreased to attain full controller output at the maximum throttle position. Use the programmer to decrease the Throttle Max parameter value, and repeat this step until the value is 100%. Setting a second bookmark at the Throttle Max parameter will allow you to toggle back and forth easily between the parameter and the Throttle % field.
- STEP 5. Now that the full throttle position results in a 100% value for Throttle %, slowly reduce throttle until the Throttle % value drops below 100% and note the throttle position. This represents the extra range of motion allowed by the throttle mechanism. If this range is large, you may wish to decrease it by increasing the Throttle Max parameter value. This will provide a larger active throttle range and more vehicle control. Using the programmer, increase the Throttle Max parameter value and repeat the test until an appropriate amount of extra range is attained.
- STEP 6. If a wigwag throttle is being used, repeat the procedure for the reverse direction. The Throttle Max value should be selected such that the throttle operates correctly in both forward and reverse.

② Tuning the Controller to the Motor

The 1243_{GEN2} controller has the flexibility to be tuned to nearly any separately excited motor from any manufacturer. The programmable parameters allow full control of the motor's maximum armature current during driving and braking and full control of the motor's maximum and minimum field current as well as the field current relationship to the armature current. This flexibility allows motor performance to be maximized while protecting it from operating outside its safe commutation region.

In order to properly tune the controller, the following information should be obtained from the motor manufacturer:

- MAXIMUM ARMATURE CURRENT RATING
- MAXIMUM FIELD CURRENT RATING
- MINIMUM FIELD CURRENT RATING
- FIELD RESISTANCE, HOT AND COLD.

The performance of a separately excited motor changes depending on temperature. This is due to the change in field winding resistance as the motor heats up through use. When the field winding temperature increases, so does its resistance; therefore, the maximum current that can be forced through the winding is reduced. Reductions in the field current over the motor's typical operating temperature range can be 10% to 50%. Since the maximum available field current determines the maximum torque that can be produced by the motor, the vehicle's performance under load and up inclines will change as the motor heats up. The change in performance can be limited by tuning the motor when it is hot rather than cold. Therefore, it is recommended that the following procedure be performed with a hot motor.

- STEP 1. Using the programmer's Program Menu, set the Drive Current Limit parameter value in each mode to the smaller of: (a) the motor's peak armature current rating, or (b) the maximum controller drive current limit. This value can later be adjusted to establish the desired vehicle driving feel in each mode.
- STEP 2. Set the Braking Current Limit parameter value in each mode to the smaller of: (a) the maximum motor armature current rating, or (b) the maximum controller braking current limit. This value can later be adjusted to establish the desired vehicle braking feel in each mode.
- STEP 3. To set the Field Max parameter value, first decide whether you want to maintain consistent vehicle operation throughout the motor's temperature range. If you do, proceed to Step 4. If, however, maintaining operational consistency across motor temperature is not a concern, but achieving maximum torque is, proceed to Step 5.
- STEP 4. For the most consistent operation across temperature, set the Field Max parameter to the maximum field current available at

low battery voltage and with a hot motor. To determine this value, divide the low battery voltage (typically 70% of nominal) by the high temperature field winding resistance specification provided by the manufacturer. Set the Field Max parameter to this value. This will provide good consistency between motor performance in both hot and cold states.

- STEP 5. For the maximum torque regardless of temperature, set the Field Max parameter to the motor's rated absolute maximum field current. To determine the absolute maximum field current, divide the nominal battery voltage by the low temperature field winding resistance specification provided by the manufacturer. Set the Field Max parameter to this value. This will provide the maximum possible torque under all conditions.

This has now set the Max Field parameter. The next step is to set the Min Field parameter. NOTE: **The Field Min parameter should never be set below the rated value specified by the manufacturer.** Operating the motor at lower field currents than specified will result in operation outside the motor's safe commutation region and will cause arcing between the brushes and commutator, significantly reducing motor and brush life. The Field Min parameter value can be increased from the manufacturer's specified value to limit the vehicle's top speed. (Setting the vehicle top speed will be addressed in tuning procedure ③.)

If the controller is tuned such that the system is operating outside the motor's safe commutation region, there will be audible and visual indications. Under normal operation, the motor will emit a whine with a pitch that increases with increasing rotation speed. If a "scratchy" sound is also heard, this is usually an indication that pin arcing is occurring in the motor and it is operating outside its safe commutation region. This operation is normally accompanied by a strong smell from the motor. If the brushes and commutator bars are visible, arcing may be visible. The further outside the safe commutation region the motor is operating, the worse the arcing will be. **Operation outside the safe commutation region is very detrimental to the motor.** The Field Min and possibly also the Field Map parameter should be increased until the indications of arcing stop. Decreasing the Field Map Start parameter will also help to move operation back into the safe commutation region.

③ Setting the Vehicle's Unloaded Top Speed

The controller and vehicle should be configured as follows prior to setting the maximum unloaded vehicle speed:

- Max Speed = 100%, all modes
- Drive Current Limit as established in tuning procedure ②
- Field Map = 50%
- Field Map Start = 50% of the specified drive current limit
- Field Min = manufacturer's specified minimum (if available); otherwise, 3 amps
- Load Comp = 0
- The vehicle should be unloaded
- The vehicle battery should be fully charged.

The vehicle should be driven on a flat surface in a clear area during this procedure. Since the vehicle may initially be traveling at speeds in excess of the final intended speed, precautions should be taken to ensure safety of test personnel and anyone in the test area.

- STEP 1. Select the programmer's Program Menu and scroll down until the Field Min parameter is at the top of the display.
- STEP 2. Power up the vehicle and apply full throttle. While driving the vehicle with full throttle applied, adjust the Field Min parameter value to set the desired top speed. Increasing the Field Min value decreases the vehicle's top speed; decreasing the Field Min value increases the vehicle's top speed. **CAUTION:** Do not decrease the Field Min parameter value below the motor manufacturer's recommended minimum field current value, and do not increase it above 10 amps.
- STEP 3. If the Field Min parameter value is increased to 10 amps and the vehicle's top speed has still not been sufficiently reduced, the Max Speed parameter should be used to bring the vehicle top speed down to the desired level. First, decrease the Field Min parameter value, setting it to optimize smooth starting. Then adjust the Max Speed parameter per Step 4 to bring the vehicle top speed down to the desired level. **NOTE:** If the Field Min parameter is set too high, the high initial torque created by the high field current may cause overly abrupt starts; this is why we recommend using the Max Speed parameter in those cases where a moderate Field Min setting does not sufficiently reduce the vehicle top speed.
- STEP 4. Scroll up the Program Menu until the Max Speed parameter is at the top of the display. While driving the vehicle with the Field Min set at the value selected in Step 3, decrease the Max Speed parameter value until the desired vehicle top speed is set.

- STEP 5. *For Walkie/Rider Applications:* Typically, different top speeds are desired for walkie and rider operation. To tune a walkie/rider vehicle's top speed, first tune it for rider operation by using the Field Min parameter. Then, to set the top speed for walkie operation, leave the Field Min parameter alone and decrease the Max Speed parameter until the desired walking vehicle speed is reached.

④ Equalization of Loaded and Unloaded Vehicle Speed

The top speed of a loaded vehicle can be set to approach the unloaded top speed by tuning the Field Map Start and Load Compensation parameters. It is recommended that you review the description of the Field Map Start and Load Compensation parameters in Section 3 before starting this procedure.

- STEP 1. The vehicle's unloaded top speed should already have been set. If it was not, it should be set before the vehicle's loaded top speed is established.
- STEP 2. Once the vehicle's unloaded top speed has been set, load the vehicle to its desired load capacity. Leave the Field Min and Speed Max parameters at the settings determined during the unloaded test.
- STEP 3A. If the intent is to minimize the difference between the loaded and unloaded vehicle speeds, then:
- (i) Drive the fully loaded vehicle on flat ground with full throttle applied. When the vehicle reaches maximum speed, observe the armature current displayed in the programmer's Monitor Menu.
 - (ii) Set the Field Map Start parameter slightly higher than the observed armature current value.
 - (iii) Test the loaded/unloaded speed variation. If the observed variation is unacceptable, proceed to "(iv)."
 - (iv) Increase the Load Compensation parameter and retest the speed regulation. The Load Comp parameter can be increased until the desired regulation is achieved or the vehicle begins to oscillate ("hunt") at low throttle. If the loaded/unloaded speed variation is acceptable but the average speed is not, adjustments can be made to the Field Min parameter.
- STEP 3B. If the intent is to make the loaded speed less than the unloaded speed (for reasons of safety, efficiency, or reduced motor heating), then:
- (i) Unload the vehicle and drive it on flat ground with full throttle applied. When the vehicle reaches maximum speed, observe the armature current displayed in the Monitor Menu.

(ii) Set the Field Map Start parameter slightly higher than the observed armature current value.

(iii) Load the vehicle and drive it on flat ground with full throttle applied. Further adjustments to the vehicle's loaded speed can now be made by varying the Field Map parameter. Increasing the Field Map value will decrease the vehicle's loaded speed, and decreasing the Field Map value will increase the vehicle's loaded speed.

CAUTION: If the Field Map Start parameter is set too high, the motor's safe commutation region may be exceeded. If this is the case, reduce the Field Map Start parameter to a safe value. Then, adjust the Field Map parameter as needed to reach the desired loaded top speed. Reducing the Field Map value will help bring the loaded speed closer to the unloaded speed. However, care must still be taken because it is possible for too low Field Map values—like too high Field Map Start values—to result in exceeding the motor's safe commutation region.

FINE TUNING

Four additional vehicle performance characteristics can be adjusted:

- ⑤ Response to Reduced Throttle
- ⑥ Response to Increased Throttle
- ⑦ Smoothness of Direction Transitions
- ⑧ Ramp Climbing.

These characteristics are related to the “feel” of the vehicle and will be different for various applications. The fine tuning adjustments are especially noticeable in precision maneuvering, which is typically Mode 1. Careful tuning of the M1 Accel Rate, M1 Decel Rate, M1 Restraint, M1 Braking Rate, and M1 Braking Current Limit parameters will ensure the most comfortable possible vehicle response at low speeds.

⑤ Response to Reduced Throttle

The way the vehicle behaves when the throttle is reduced or completely released can be adjusted to suit your application, using the Decel Rate and Restraint parameters. Refer to the description of these parameters in Section 3 before beginning this procedure.

- STEP 1. Set the Decel Rate based on the desired time for the vehicle to stop upon release of throttle when traveling at full speed with full load. If the vehicle brakes too abruptly when the throttle is released, increase the Decel Rate.

- STEP 2. The default Restraint setting (5 amps) should work well for most vehicles. If the vehicle exhibits excessive overspeed when driving down a ramp, increase the Restraint value. If the vehicle “speed hunts” while driving down a ramp or brakes too abruptly at low or released throttle, decrease the Restraint value.
- STEP 3. If the Restraint value has been adjusted, retest braking behavior when throttle is reduced to ensure that it still has the desired feel. If it does not, the Decel Rate should be re-adjusted as in Step 1.

⑥ Response to Increased Throttle

The way the vehicle reacts to quick or slow increased throttle requests can be modified using the Accel Rate, Current Ratio, Quick Start, and Throttle Map parameters. Optimal vehicle response is tuned by adjusting these parameters and then accelerating the vehicle from a dead stop under various throttle transition conditions.

- STEP 1. Set Quick Start = 0 and Throttle Map = 50%.
- STEP 2. Drive the vehicle and adjust the Accel Rate for the best overall response. If the vehicle starts too slowly under all driving conditions, the Accel Rate should be reduced.
- STEP 3. Increasing vehicle acceleration. If acceleration feels good for slow or moderate throttle transitions but the vehicle initially starts too slowly, set the Current Ratio parameter to 2 or higher. If the vehicle does not accelerate as quickly as desired when the throttle is transitioned quickly from zero to full speed, increase the Quick Start parameter value to obtain the desired fast throttle response.
- STEP 4. Achieving better control at low speeds. If the vehicle responds well for fast, full range throttle transitions but is too jumpy during low speed maneuvering, reduce the Throttle Map and/or set the Current Ratio to 1. If these adjustments are insufficient, decrease the Quick Start parameter value to obtain the desired precision maneuvering.

⑦ Smoothness of Direction Transitions

Additional fine tuning can be performed to enhance the vehicle’s transitions between braking and driving, after the major performance and responsiveness tuning—① through ⑥ above—has been completed.

- STEP 1. Ensure that the Braking Current Limit and Braking Rate parameters have been set for the desired response (*see Section 3, pages 23 and 24*).

- STEP 2. If the transition is too abrupt: increase the Taper Rate and/or set the Variable Braking parameter to On. Secondary adjustments can be made by increasing the Accel Rate.
- STEP 3. If the transition is too slow: decrease the Taper Rate and set Creep Speed to 5% or greater. Secondary adjustments can be made by decreasing the Accel Rate, increasing the Current Ratio, or increasing the Quick Start parameter value.

⑧ Ramp Climbing

The vehicle response to increased gradients such as loading ramps can be tuned via the Field Map parameter. Decreasing the Field Map parameter allows faster vehicle speeds while climbing ramps, but it also has the effect of reducing the ability of the controller to generate torque in the vehicle's mid range speeds.

- STEP 1. If faster vehicle speed is desired when climbing ramps, decrease the Field Map parameter value until the desired ramp climbing speed is attained. It should be noted that if the motor's torque capability is exceeded under the conditions of load weight and ramp gradient, vehicle speed will be limited by the motor's capability and the desired vehicle speed may not be attainable. The system will find a compromise point at which sufficient motor torque is generated to climb the ramp at an acceptable speed. If the Field Map parameter value is reduced to 0% and the desired speed is still not attained, the system is being limited by the motor's torque capability under these operating conditions. **CAUTION:** be careful when reducing the Field Map parameter since at low Field Map values it is possible that the motor could be operated outside its safe commutation region.
- STEP 2. If the drive system cannot produce sufficient torque for a fully loaded vehicle to climb the desired ramp, try increasing the Field Map, Field Max, and/or Drive Current Limit parameters. The impact of increasing these parameter values on other driving characteristics must be evaluated. Increasing the Field Max will provide more field current, and increasing the Drive Current Limit will provide more armature current. If the Field Max is set at the manufacturer's specified limit and the Drive Current Limit is set at the rated maximum, then vehicle speed up the ramp is limited by the motor or the vehicle's gearing and cannot be increased by tuning the controller. **NOTE:** To determine if the controller's armature current is at its set value during ramp climbing, read the "Arm Current" in the programmer's Monitor Menu.

6

PROGRAMMER MENUS

The universal handheld Curtis programmers allow you to program, test, and diagnose Curtis programmable controllers. For information about 1311 programmer operation, see Appendix B. If you are using the older 1307 programmer, consult your existing documentation if necessary.

Note that depending on the specific 1243^{GEN2} model you have, some of the menu items may not appear.

1243^{GEN2} PROGRAM MENU

VOLTAGE	Nominal battery voltage, in volts
M1 DRIVE C/L	Mode 1 drive current limit, in amps
M2 DRIVE C/L	Mode 2 drive current limit, in amps
M3 DRIVE C/L	Mode 3 drive current limit, in amps
M4 DRIVE C/L	Mode 4 drive current limit, in amps
M1 BRAKE C/L	Mode 1 braking current limit, in amps
M2 BRAKE C/L	Mode 2 braking current limit, in amps
M3 BRAKE C/L	Mode 3 braking current limit, in amps
M4 BRAKE C/L	Mode 4 braking current limit, in amps
M1 ACCEL RATE	Mode 1 acceleration rate, in seconds
M2 ACCEL RATE	Mode 2 acceleration rate, in seconds
M3 ACCEL RATE	Mode 3 acceleration rate, in seconds
M4 ACCEL RATE	Mode 4 acceleration rate, in seconds
M1 DECEL RATE	Mode 1 deceleration rate, in seconds
M2 DECEL RATE	Mode 2 deceleration rate, in seconds
M3 DECEL RATE	Mode 3 deceleration rate, in seconds
M4 DECEL RATE	Mode 4 deceleration rate, in seconds
THROTTLE DECEL	Time for transition to braking mode, in seconds
M1 BRAKE RATE	Mode 1 braking rate, in seconds
M2 BRAKE RATE	Mode 2 braking rate, in seconds
M3 BRAKE RATE	Mode 3 braking rate, in seconds
M4 BRAKE RATE	Mode 4 braking rate, in seconds
INT BRAKE RATE	Interlock braking rate, in seconds
QUICK START	Quick-start throttle factor
TAPER RATE	Threshold affecting end of regen during direction reversal: 1 to 20
M1 MAX FWD SPD	Mode 1 maximum forward speed, as % drive output
M2 MAX FWD SPD	Mode 2 maximum forward speed, as % drive output
M3 MAX FWD SPD	Mode 3 maximum forward speed, as % drive output
M4 MAX FWD SPD	Mode 4 maximum forward speed, as % drive output
M1 MAX REV SPD	Mode 1 maximum reverse speed, as % drive output

Program Menu, cont'd

M2 MAX REV SPD	Mode 2 maximum reverse speed, as % drive output
M3 MAX REV SPD	Mode 3 maximum reverse speed, as % drive output
M4 MAX REV SPD	Mode 4 maximum reverse speed, as % drive output
CREEP SPEED	Creep speed, as % drive output
THROTTLE TYPE	Type of throttle input ¹
THRTL DEADBAND	Throttle neutral deadband, as %
THROTTLE MAX	Throttle input req'd for 100% drive output, as %
THROTTLE MAP	Drive output at 50% throttle input, as %
FIELD MIN	Minimum field current, in amps
FIELD MAX	Maximum field current, in amps
FLD MAP START	Armature current at which field map takes effect, in amps
FIELD MAP	Field current map setting, as %
CURRENT RATIO	Current ratio: factor of 1, 2, 4, or 8
M1 RESTRAINT	Mode 1 restraint braking, in amps
M2 RESTRAINT	Mode 2 restraint braking, in amps
M3 RESTRAINT	Mode 3 restraint braking, in amps
M4 RESTRAINT	Mode 4 restraint braking, in amps
LOAD COMP	Load compensation: 0 to 25% drive output
HPD	High pedal disable (HPD) type ²
SRO	Static return to off (SRO) type ³
SEQUENCING DLY	Sequencing delay, in seconds
MAIN CONT INTR	Main contactor uses interlock input: On or Off
MAIN OPEN DLY	Main contactor open delay: On or Off
CONT DIAG	Contactors diagnostics: On or Off
AUX TYPE	Auxiliary driver type ⁴
AUX DELAY	Auxiliary driver open delay, in seconds
EMR REV C/L	Emergency reverse current limit, in amps
EMR REV CHECK	Emergency reverse wiring check: On or Off
EMR DIR INTR	Emergency reverse direction interlock: On or Off
VARIABLE BRAKE	Variable braking: On or Off
ANTI-TIEDOWN	Anti-tiedown: On or Off
POT LOW FAULT	Pot Low fault: On or Off
FULL VOLTS	Voltage considered 100% state of charge, in volts
EMPTY VOLTS	Voltage considered 0% state of charge, in volts
RESET VOLTS	Voltage at which state of charge resets to 100%, in volts
BATTERY ADJUST	BDI algorithm adjustment to compensate for battery capacity, in secs
BDI LOCKOUT	Fault 2 output high when BDI%=0: On or Off
BDI DISABLE	Battery s-o-c <1% invokes BDI Limit Speed: On or Off

Program Menu, cont'd

ADJ HRS LOW	Hourmeter preset low byte: 0–99
ADJ HRS MID	Hourmeter preset middle byte: 0–99
ADJ HRS HIGH	Hourmeter preset high byte: 0–99
SET TOTL HRS	Apply preset values to total hourmeter: On or Off
SET TRAC HRS	Apply preset values to traction hourmeter: On or Off
HOURLMETER TYPE	Total hourmeter is default display: On or Off
SRVC TOTL HRS	Total service timer setting, in hundreds of hours
SRVC TRAC HRS	Traction service timer setting, in hundreds of hours
SRVC TOTL	Reset total service timer: On or Off
SRVC TRAC	Reset traction service timer: On or Off
DIS TOTL HRS	Total disable timer setting, in hours
DIS TRAC HRS	Total traction timer setting, in hours
TRAC FAULT SPD	Max. drive speed if disable timer expires, as %
BDI LIMIT SPD	Max. drive speed upon BDI disable, as %
WARM SPEED	Max. drive speed if Mot Wrm resistance exceeds setpoint, as %
MOT WRM x10 mΩ	Field resistance setpoint for Warm Speed, in 10-milliohm units
MOT HOT x10 mΩ	Field resistance at which no drive output, in 10-milliohm units
MOTOR Ω COMP	Enable cutback/cutoff response to motor overtemp.: On or Off
MAX REV REGEN	Max. intk braking regen current fr. rev., <u>max.</u> load, in amps
MAX FWD REGEN	Max. intk braking regen current fr. fwd., <u>max.</u> load, in amps
MIN REV REGEN	Max. intk braking regen current fr. rev., <u>min.</u> load, in amps
MIN FWD REGEN	Max. intk braking regen current fr. fwd., <u>min.</u> load, in amps
MAX LOAD VOLTS	Voltage on load sensor for <u>max.</u> regen current, in volts
MIN LOAD VOLTS	Voltage on load sensor for <u>min.</u> regen current, in volts
INT BRAKE DLY	Delay before E-M brake applied after intk switch opens, in secs
FAULT CODE	Fault code: On or Off
EM BRAKE PWM	Enables modulation of brake driver output: On or Off
FIELD CHECK	Fault will register if open detected in field: On or Off
PUMP METER	Enables use of Pin 2 as input for a pump hourmeter: On or Off

Program Menu Notes

¹ Throttle types (for detail, see Throttle Wiring in Section 2)

Type 1: 5k Ω –0 potentiometers

Type 2: single-ended 0–5V, 3-wire pot, current source, and electronic throttles

Type 3: 0–5k Ω potentiometers

Type 4: wigwag 0–5V and 3-wire pot throttles

² HPD types (for detail, see Section 3: Programmable Parameters, page 41)

Type 0: no HPD

Type 1: HPD fault unless KSI and interlock inputs are received before a throttle request >25%

Type 2: HPD fault unless KSI input is received before a throttle request >25%

³ SRO types (for detail, see Section 3: Programmable Parameters, page 42)

Type 0: no SRO

Type 1: SRO fault unless KSI + interlock inputs are received before a direction is selected

Type 2: SRO fault unless KSI + interlock inputs (in that order) are received before a direction is selected

Type 3: SRO fault unless KSI + interlock + forward inputs received in that order; a reverse input can be received at any point in the sequence.

⁴ Auxiliary driver types (for detail, see Table 3, page 30)

1243GEN2 MONITOR MENU

THROTTLE %	Throttle reading, as % of full throttle
FIELD CURRENT	Motor field current, in amps
ARM CURRENT	Motor armature current, in amps
FIELD PWM	Motor field applied duty cycle, as %
ARM PWM	Motor armature applied duty cycle, as %
BDI %	Battery state of charge, as % of full charge
LOAD VOLTAGE	Load sensor voltage, in volts
BATT VOLTAGE	Battery voltage across the capacitors, in volts
MOT RES x10 mΩ	Motor field winding resistance, in 10-milliohm units
HEATSINK TEMP	Heatsink temperature, in °C
TOT SRVC X25	Total service hours, multiple of 25
+TOT SRVC	Total service hours, in hours
TRAC SRVC X25	Total traction hours, multiple of 25
+TRAC SRVC	Total traction hours, in hours
FORWARD INPUT	Forward switch: on/off [neutral switch for Type 4 throttle]
REVERSE INPUT	Reverse switch: on/off
MODE INPUT A	Mode Select 1 switch: on/off
MODE INPUT B	Mode Select 2 switch: on/off
INTERLOCK	Interlock switch: on/off
EMR REV INPUT	Emergency reverse switch: on/off
MAIN CONT	Main contactor: on/off
AUX DRIVER	Auxiliary driver: on/off
SYS MODE	Operating mode: 0–6 [0=neutral, 1=drive, 2=regen, 3=regen taper, 4=field reversal, 5=aux driver Off, 6=disable (major fault)]

Note: If you are using the older 1307 programmer, the 1311's Monitor Menu is called the Test Menu.

1243^{GEN2} SYSTEM FAULTS MENU

This is a list of the possible fault messages you may see displayed by the programmer. The messages are listed here in alphabetical order for easy reference.

ANTI - TIEDOWN	Mode Select 1 switch closed at startup
FIELD SHORT	Contactora coil or motor field winding shorted
CURRENT SHUNT FAULT	Current sensor error
EMR REV WIRING	Emergency reverse wiring check failed
FIELD OPEN	Motor field winding open
HPD	High pedal disable (HPD) activated
HW FAILSAFE	Hardware failsafe activated
LOW BATTERY VOLTAGE	Battery voltage too low
M- SHORTED	M- shorted to B-
MAIN CONT WELDED	Welded main contactor
MISSING CONTACTOR	Missing contactor
MOTOR HOT	Field winding resistance at disable setpoint
MOTOR WARM	Field winding resistance at cutback setpoint
NO KNOWN FAULTS	No known faults
OVERVOLTAGE	Battery voltage too high
SRO	Static return to off (SRO) activated
SRVC TOTAL	Total service timer expired
SRVC TRAC	Traction service timer expired
THERMAL CUTBACK	Cutback, due to over-/undertemperature
THROTTLE WIPER HI	Throttle wiper input too high
THROTTLE WIPER LO	Throttle wiper input too low
TOTAL DISABLED	Total disable timer expired
TRAC DISABLED	Traction disable timer expired

Note: If you are using the older 1307 programmer, the 1311's System Faults Menu is called the Diagnostics Menu.

7

DIAGNOSTICS AND TROUBLESHOOTING

The 1243GEN2 controller provides diagnostics information to assist technicians in troubleshooting drive system problems. The diagnostics information can be obtained by observing the appropriate display on the handheld programmer, the fault message displayed on the Spyglass gauge, the fault codes issued by the Status LED, or the fault display driven by the controller's fault outputs (Fault 1 and Fault 2). Refer to the troubleshooting chart (Table 7) for suggestions covering a wide range of possible faults.

PROGRAMMER DIAGNOSTICS

The handheld programmer presents complete diagnostic information in plain language. Faults are displayed in the System Faults Menu, and the status of the controller inputs/outputs is displayed in the Monitor Menu.

Accessing the programmer's Fault History Menu provides a list of the faults that have occurred since the fault history file was last cleared. Checking (and clearing) the fault history file is recommended each time the vehicle is brought in for maintenance.

For information on 1311 programmer operation, see Appendix B. If you are using the older 1307 programmer, refer to existing documentation.

SPYGLASS DIAGNOSTICS

The eight-character LCD on the Spyglass displays a continuous sequence of hourmeter, battery state-of-charge, and fault messages.

Fault messages are displayed using the same codes that are flashed by the LED (see Table 8). For example, the LED flashes 3,2 for a welded main contactor:

□□□ □□ (3 , 2)	□□□ □□ (3 , 2)	□□□ □□ (3 , 2)
---------------------	---------------------	---------------------

and the corresponding Spyglass message is:

CODE 32

When a fault message is being displayed, the red Fault LED (labeled with a wrench symbol) flashes to catch the operator's attention.

The LCD also displays a warning when either service timer expires. The service warning is not considered a fault and the red Fault LED does not flash. The word SERVICE is displayed for about 20 seconds on each key-on, after the hourmeter is displayed.

The Spyglass is available in 3-LED and 6-LED models; see Figure 21.

Table 7 TROUBLESHOOTING CHART

LED CODE	PROGRAMMER LCD DISPLAY	FAULT CATEGORY	POSSIBLE CAUSE	FAULT CLEARANCE
0,1	NO KNOWN FAULTS	0	n/a	n/a
1,1	CURRENT SHUNT FAULT	1	<ol style="list-style-type: none"> 1. Abnormal vehicle operation causing high current spikes. 2. Current sensor out of range. 3. Controller failure. 	Cycle KSI. If problem persists, replace controller.
1,2	HW FAILSAFE	1	<ol style="list-style-type: none"> 1. Noisy environment. 2. Self-test or watchdog fault. 3. Controller failure. 	Cycle KSI. If problem persists, replace controller.
1,3	M- SHORTED	1	<ol style="list-style-type: none"> 1. Internal or external short of M- to B-. 2. Incorrect motor wiring. 3. Controller failure. 	Check wiring; cycle KSI. If problem persists, replace controller.
1,4	SRO	3	<ol style="list-style-type: none"> 1. Improper sequence of KSI, interlock, and direction inputs. 2. Interlock or direction switch circuit open. 3. Sequencing delay too short. 4. Wrong SRO or throttle type selected. 5. Misadjusted throttle pot. 	Follow proper sequence; adjust throttle if necessary; adjust programmable parameters if necessary.
2,1	THROTTLE WIPER HI	1	<ol style="list-style-type: none"> 1. Throttle input wire open or shorted to B+. 2. Defective throttle pot. 3. Wrong throttle type selected. 	When Throttle Wiper High input returns to valid range.
2,2	EMR REV WIRING	1	<ol style="list-style-type: none"> 1. Emergency reverse wire or check wire open. 	Re-apply emergency reverse or cycle interlock.
2,3	HPD	3	<ol style="list-style-type: none"> 1. Improper sequence of KSI, interlock, and throttle inputs. 2. Misadjusted throttle pot. 3. Sequencing delay too short. 3. Wrong HPD or throttle type selected. 5. Misadjusted throttle pot. 	Follow proper sequence; adjust throttle if necessary; adjust programmable parameters if necessary.
	SRVC TOTAL	3	<ol style="list-style-type: none"> 1. Total maintenance timer expired. 	Reset with programmer.
	SRVC TRAC	3	<ol style="list-style-type: none"> 1. Traction maintenance timer expired. 	Reset with programmer.
	TOTAL DISABLED	3	<ol style="list-style-type: none"> 1. Total disable timer expired. 	Reset with programmer.
	TRAC DISABLED	3	<ol style="list-style-type: none"> 1. Traction disable timer expired. 	Reset with programmer.
2,4	THROTTLE WIPER LO	1	<ol style="list-style-type: none"> 1. Throttle pot wire open or shorted to B+. 2. Wrong throttle type selected. 3. Defective throttle pot. 	When Throttle Wiper Low input returns to valid range.
3,1	FIELD SHORT	1	<ol style="list-style-type: none"> 1. Main contactor coil shorted. 2. Field winding shorted to B+ or B-. 3. Field resistance too low. 	Check contactor coil and field winding; cycle KSI.
3,2	MAIN CONT WELDED	1	<ol style="list-style-type: none"> 1. Main contactor stuck closed. 2. Main contactor driver shorted. 	Check wiring and contactor; cycle KSI.
3,3	FIELD OPEN	1	<ol style="list-style-type: none"> 1. Field winding connection open. 2. Field winding open. 	Check wiring and cycle KSI.
3,4	MISSING CONTACTOR	1	<ol style="list-style-type: none"> 1. Main contactor coil open. 2. Main contactor missing. 3. Wire to main contactor open. 	Check wiring and cycle KSI.

Table 7 TROUBLESHOOTING CHART, cont'd

LED CODE	PROGRAMMER LCD DISPLAY	FAULT CATEGORY	POSSIBLE CAUSE	FAULT CLEARANCE
4,1	LOW BATTERY VOLTAGE	2	1. Battery voltage < undervoltage cutback. 2. Corroded battery terminal. 3. Loose battery or controller terminal.	When voltage rises above undervoltage cutoff point.
4,2	OVERVOLTAGE	2	1. Battery voltage > overvoltage shutdown limit. 2. Vehicle operating with charger attached.	When voltage falls below overvoltage cutoff point.
4,3	THERMAL CUTBACK	2	1. Temperature >85°C or < -25°C. 2. Excessive load on vehicle. 3. Improper mounting of controller.	Clears when heatsink temperature returns to within acceptable range.
4,4	ANTI - TIEDOWN	3	1. Mode switches shorted to B+. 2. Mode Select 1 “tied down” to select Mode 2 or Mode 4 permanently.	Release Mode Select 1.
	MOTOR HOT	3	1. Field resistance > motor hot setpoint.	When resistance < setpoint.
	MOTOR WARM	3	1. Field resistance > motor warm setpoint.	When resistance < setpoint.

Fig. 21 *Curtis 840 Spyglass, 3-LED and 6-LED models.*

3-LED Spyglass

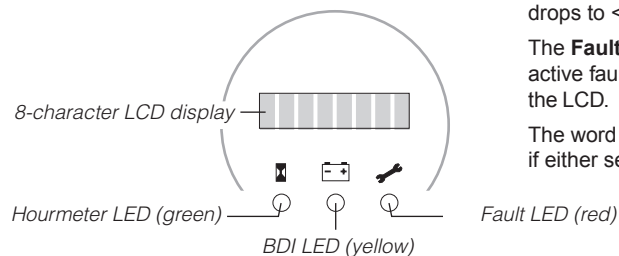

The **hourmeter LED** lights when the LCD is displaying hourmeter data.

The **BDI LED** lights when the LCD is displaying BDI%. It flashes when BDI% drops to <10%.

The **Fault LED** flashes to indicate an active fault, and the fault code appears on the LCD.

The word SERVICE is displayed at key-on if either service timer has expired.

6-LED Spyglass

The three green **BDI LEDs** function as a bargraph showing BDI% between 52% and 100%.

Yellow LED = 36% – 51% BDI.

Red LED steady = 20% – 35% BDI.

Red LED flashing = 0 – 19% BDI.

The **Fault LED** flashes to indicate an active fault, and the fault code appears on the LCD.

The word SERVICE is displayed at key-on if either service timer has expired.

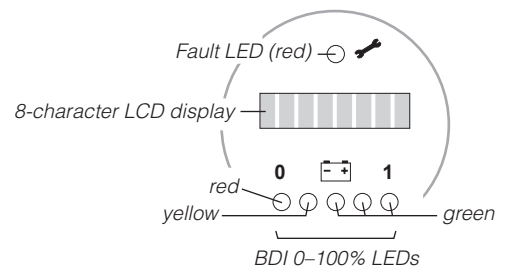

STATUS LED DIAGNOSTICS

A Status LED is built into the 1243GEN2 controller. It is visible through a window in the label on top of the controller. This Status LED displays fault codes when there is a problem with the controller or with the inputs to the controller. During normal operation, with no faults present, the Status LED flashes steadily on and off. If the controller detects a fault, a 2-digit fault identification code is flashed continuously until the fault is corrected. For example, code “3,2”—main contactor welded—appears as:

□□□ □□ (3 , 2)	□□□ □□ (3 , 2)	□□□ □□ (3 , 2)
---------------------	---------------------	---------------------

The codes are listed in Table 8.

LED CODES		EXPLANATION
<i>LED off</i>	████████	no power or defective controller controller or microprocessor fault
<i>solid on</i>	□□□□□□	
0,1	■ □	controller operational; no faults
1,1	□ □	current sensor error
1,2	□ □□	hardware failsafe fault
1,3	□ □□□	M- fault or motor output short
1,4	□ □□□□	static return to off (SRO)
2,1	□□ □	throttle wiper high
2,2	□□ □□	emergency reverse circuit check fault
2,3	□□ □□□	high pedal disable (HPD), or expired timer
2,4	□□ □□□□	throttle wiper low
3,1	□□□ □	contactor driver overcurrent or field winding short
3,2	□□□ □□	main contactor welded
3,3	□□□ □□□	field winding open
3,4	□□□ □□□□	missing contactor
4,1	□□□□ □	low battery voltage
4,2	□□□□ □□	overvoltage
4,3	□□□□ □□□	thermal cutback, due to over/under temp
4,4	□□□□ □□□□	anti-tiedown fault, or overheated motor

Note: Only one fault is indicated at a time, and faults are not queued up. Refer to the troubleshooting chart (Table 7) for suggestions about possible causes of the various faults. Operational faults—such as a fault in SRO sequencing—are cleared by cycling the interlock switch or keyswitch.

FAULT OUTPUT LED DIAGNOSTICS

The 1243GEN2 controller provides two fault outputs designed to transmit fault information to LEDs located on the display panel or on any remote panel. These outputs can be programmed to display faults in Fault Code format or in Fault Category format—see *Section 3, page 51*.

In Fault Code format, the two fault outputs operate independently. The Fault 1 line flashes the same codes, at the same time, as the controller's built-in Status LED (see Table 8). The Fault 2 line pulls low when a fault is present; it can be used to drive an LED that simply indicates whether or not there is a fault. When no faults are present, both of the fault lines are in their normal state (high).

In Fault Category format, the two fault outputs together define one of four fault categories, as listed in Table 9. When a fault occurs, the Fault 1 and Fault 2 lines (Pins 2 and 3) go to the state indicating the category of the particular fault: **LOW**/HIGH, HIGH/**LOW**, or **LOW**/**LOW**. When the fault is cleared, the fault outputs return to their normal state (i.e., HIGH/HIGH).

FAULT 1 OUTPUT	FAULT 2 OUTPUT	FAULT CATEGORY	POSSIBLE FAULT
HIGH	HIGH	0	(no known faults)
LOW	HIGH	1	Current shunt fault Hardware failsafe fault M- shorted Throttle wiper high or low Emergency reverse wiring fault Field winding open Contactor coil or field shorted Main contactor welded or missing
HIGH	LOW	2	Low battery voltage Overvoltage Thermal cutback, due to over/under temp
LOW	LOW	3	Anti-tiedown fault High pedal disable (HPD) fault Static return to off (SRO) fault Service timer or disable timer expired Motor too hot

8

CONTROLLER MAINTENANCE

There are no user serviceable parts in the Curtis 1243GEN2 controller. **No attempt should be made to open, repair, or otherwise modify the controller.** Doing so may damage the controller and will void the warranty.

It is recommended that the controller be kept clean and dry and that its fault history file be checked and cleared periodically.

CLEANING

Periodically cleaning the controller exterior will help protect it against corrosion and possible electrical control problems created by dirt, grime, and chemicals that are part of the operating environment and that normally exist in battery powered systems.



When working around any battery powered vehicle, proper safety precautions should be taken. These include, but are not limited to: proper training, wearing eye protection, and avoiding loose clothing and jewelry.

Use the following cleaning procedure for routine maintenance.

1. Remove power by disconnecting the battery.
2. Discharge the capacitors in the controller by connecting a load (such as a contactor coil or a horn) across the controller's **B+** and **B-** terminals.
3. Remove any dirt or corrosion from the connector areas. The controller should be wiped clean with a moist rag. Dry it before reconnecting the battery. The controller should not be subjected to pressured water flow from either a standard hose or a power washer.
4. Make sure the connections are tight, but do not overtighten them. See Section 2, page 7, for maximum tightening torque specifications for the battery and motor connections.

FAULT HISTORY FILE

The handheld programmer can be used to access the controller's fault history file. The programmer will read out all the faults the controller has experienced since the last time the history file was cleared. Faults such as contactor faults may be the result of loose wires; contactor wiring should be carefully checked. Faults such as overtemperature may be caused by operator habits or by overloading.

After a problem has been diagnosed and corrected, it is a good idea to clear the fault history file. This allows the controller to accumulate a new file of faults. By checking the new history file at a later date, you can readily determine whether the problem was indeed fixed.

For instructions on accessing the history file, see Appendix B.

APPENDIX A

VEHICLE DESIGN CONSIDERATIONS REGARDING ELECTROMAGNETIC COMPATIBILITY (EMC) AND ELECTROSTATIC DISCHARGE (ESD)

ELECTROMAGNETIC COMPATIBILITY (EMC)

Electromagnetic compatibility (EMC) encompasses two areas: emissions and immunity. *Emissions* are radio frequency (rf) energy generated by a product. This energy has the potential to interfere with communications systems such as radio, television, cellular phones, dispatching, aircraft, etc. *Immunity* is the ability of a product to operate normally in the presence of rf energy.

EMC is ultimately a system design issue. Part of the EMC performance is designed into or inherent in each component; another part is designed into or inherent in end product characteristics such as shielding, wiring, and layout; and, finally, a portion is a function of the interactions between all these parts. The design techniques presented below can enhance EMC performance in products that use Curtis motor controllers.

Decreasing Emissions

Motor brush arcing can be a significant source of rf emissions. These emissions may be reduced by installing bypass capacitors across the motor wires and/or between each motor wire and the motor frame. If the latter approach is used, the voltage rating and leakage characteristics of the capacitors must be adequate to meet any safety regulations regarding electrical connections between a battery operated circuit and the chassis. The bypass capacitor should be installed as close to the motor as possible, or even inside it, to provide the best performance. Alternatively a ferrite bead can be installed on the wires, as close as possible to the motor. In some instances, capacitors and ferrite beads may both be appropriate. Another option is to choose a motor with a brush material that will result in less arcing to the commutator. Brushes that have been run in for approximately 100 hours will typically generate lower emissions than new brushes because there is less arcing after they are properly seated.

The motor drive output from Curtis controllers can also make a contribution to rf emissions. This output is a pulse width modulated square wave with rather fast rise and fall times that are rich in harmonics. The impact of these switching waveforms can be minimized by making the wires from the controller to the motor as short as possible. Ferrite beads installed on the drive wires can further reduce these emissions. For applications requiring very low emissions, the solution may involve enclosing the controller, interconnect wires, and motor together in one shielded box. The motor drive harmonics can couple to battery supply leads and throttle circuit wires, so ferrite beads may also be required on these other wires in some applications.

Increasing Immunity

Immunity to radiated electric fields can be achieved either by reducing the overall circuit sensitivity or by keeping the undesired signals away from this circuitry. The controller circuitry itself cannot be made less sensitive, since it must accurately detect and process low level signals from the throttle potentiometer. Thus immunity is generally achieved by preventing the external rf energy from coupling into sensitive circuitry. This rf energy can get into the controller circuitry via conducted paths and via radiated paths.

Conducted paths are created by the wires connected to the controller. These wires act as antennas and the amount of rf energy coupled into these wires is generally proportional to their length. The rf voltages and currents induced in each wire are applied to the controller pin to which the wire is connected. Curtis motor controllers include bypass capacitors on the printed circuit board's throttle wires to reduce the impact of this rf energy on the internal circuitry. In some applications, ferrite beads may also be required on the various wires to achieve desired performance levels.

Radiated paths are created when the controller circuitry is immersed in an external field. This coupling can be reduced by enclosing the controller in a metal box. Some Curtis motor controllers are enclosed by a heat sink that also provides shielding around the controller circuitry, while others are unshielded. In some applications, the vehicle designer will need to mount the controller within a shielded box on the end product. The box may be constructed of just about any metal, although steel and aluminum are most commonly used.

Most coated plastics do not provide good shielding because the coatings are not true metals, but rather a mixture of small metal particles in a non-conductive binder. These relatively isolated particles may appear to be good based on a dc resistance measurement but do not provide adequate electron mobility to yield good shielding effectiveness. Electroless plating of plastic will yield a true metal and can thus be effective as an rf shield, but it is usually more expensive than the coatings.

A contiguous metal enclosure without any holes or seams, known as a Faraday cage, provides the best shielding for the given material and frequency. When a hole or holes are added, rf currents flowing on the outside surface of the shield must take a longer path to get around the hole than if the surface was contiguous. As more "bending" is required of these currents, more energy is coupled to the inside surface, and thus the shielding effectiveness is reduced. The reduction in shielding is a function of the longest linear dimension of a hole rather than the area. This concept is often applied where ventilation is necessary, in which case many small holes are preferable to a few larger ones.

Applying this same concept to seams or joints between adjacent pieces or segments of a shielded enclosure, it is important to minimize the open length of these seams. Seam length is the distance between points where good ohmic contact is made. This contact can be provided by solder, welds, or pressure contact. If pressure contact is used, attention must be paid to the corrosion characteristics of the shield material and any corrosion-resistant processes

applied to the base material. If the ohmic contact itself is not continuous, the shielding effectiveness can be maximized by making the joints between adjacent pieces overlapping rather than abutted.

The shielding effectiveness of an enclosure is further reduced when a wire passes through a hole in the enclosure. RF energy on the wire from an external field is re-radiated into the interior of the enclosure. This coupling mechanism can be reduced by filtering the wire at the point where it passes through the boundary of the shield. Given the safety considerations involved with connecting electrical components to the chassis or frame in battery powered vehicles, such filtering will usually consist of a series inductor (or ferrite bead) rather than a shunt capacitor. If a capacitor is used, it must have a voltage rating and leakage characteristics that will allow the end product to meet applicable safety regulations.

The B+ (and B-, if applicable) wires that supply power to the throttle control panel—such as for the keyswitch—should be bundled with the remaining throttle wires so that all these wires are routed together. If the wires to the control panel are routed separately, a larger loop area is formed. Larger loop areas produce more efficient antennas which will result in decreased immunity performance.

ELECTROSTATIC DISCHARGE (ESD)

Curtis motor controllers contain ESD-sensitive components, and it is therefore necessary to protect them from ESD damage. Electrostatic discharge (ESD) immunity is achieved either by providing sufficient distance between conductors and the outside world so that a discharge will not occur, or by providing an intentional path for the discharge current such that the circuit is isolated from the electric and magnetic fields produced by the discharge. In general the guidelines presented above for increasing the radiated immunity will also provide increased ESD immunity.

It is usually easier to prevent the discharge from occurring than to divert the current path. A fundamental technique for ESD prevention is to provide adequately thick insulation between all metal conductors and the outside environment so that the voltage gradient does not exceed the threshold required for a discharge to occur. If the current diversion approach is used, all exposed metal components must be grounded. The shielded enclosure, if properly grounded, can be used to divert the discharge current; it should be noted that the location of holes and seams can have a significant impact on the ESD suppression. If the enclosure is not grounded, the path of the discharge current becomes more complex and less predictable, especially if holes and seams are involved. Some experimentation may be required to optimize the selection and placement of holes, wires, and grounding paths. Careful attention must be paid to the control panel design so that it can tolerate a static discharge.

APPENDIX B

CURTIS 1311 HANDHELD PROGRAMMER

The Curtis 1311 handheld programmer provides programming, diagnostic, and test capabilities for the 1243GEN2 controller. The power for operating the programmer is supplied by the host controller via a 4-pin Molex connector.

The programmer includes a 7-line alphanumeric LCD display, rocker-type keys for navigating through the display and for modifying parameters (+/-), and three keys that can be used as bookmarks.

The 1311 programmer is easy to use, with self-explanatory functions. After plugging in the programmer, wait a few seconds for it to boot up and gather information from the controller.

For experimenting with settings, the programmer can be left plugged in while the vehicle is driven.

Fig. B-1 *Curtis 1311 handheld programmer.*

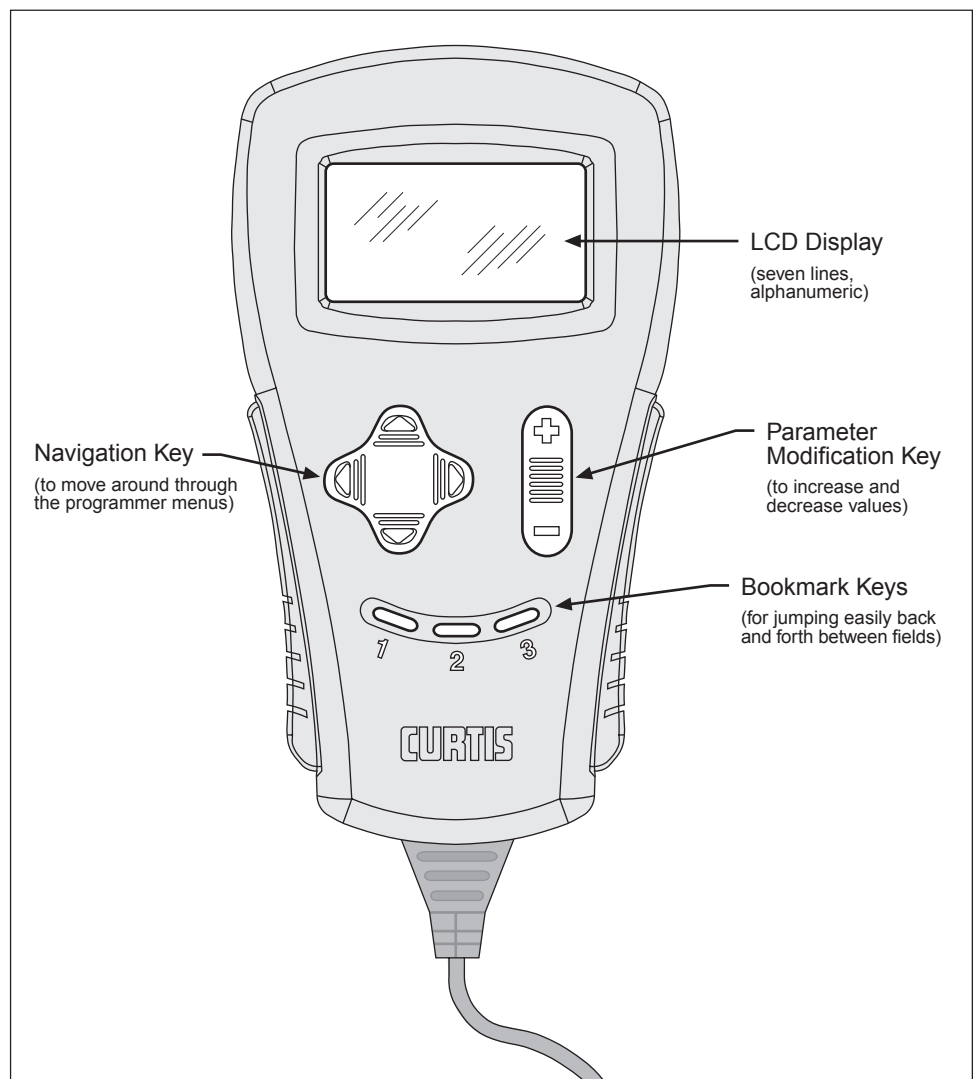

The bookmark keys allow you to quickly go back to up to three selected items without having to navigate back through the menu structure. To set a bookmark, press one of the bookmark keys for about three seconds, until the Bookmark Set screen is displayed. To jump to a set bookmark location, quickly press the appropriate bookmark key (1, 2, or 3). Note that the bookmarks are not permanently stored in the programmer. They are cleared when the programmer is unplugged.

The bookmark keys can be used to make parameter adjustment easier. For example, in adjusting the throttle deadband, you might set a bookmark at the Throttle % readout [Monitor > *THROTTLE* %] and another at the Throttle Deadband parameter [Program > *THROTTLE DB*]; this way you can easily toggle between the readout and the parameter.

1311 PROGRAMMER MENUS

There are six main menus, which in turn lead to nested submenus:

Program — provides access to the individual programmable parameters (see page 65).

Monitor — presents real-time values during vehicle operation (see page 69).

Faults — presents diagnostic information on active system faults (see page 70), and also provides access to the fault history file and a means to clear the fault history file.

Functions — provides access to the controller-cloning commands (see page 52) and to the “reset” command.

Information — displays data about the host controller: model and serial numbers, date of manufacture, hardware and software versions, and itemization of other devices that may be associated with the controller’s operation.

Programmer Setup — displays data about the programmer: model and serial numbers, date of manufacture, hardware and software versions, and a list of the programmable parameters that can be accessed with this particular programmer.

APPENDIX C

PROGRAMMABLE PARAMETERS INDEX

The 1243^{GEN2} controller's programmable parameters are listed below in alphabetical order (by programmer display name), with references provided to the main entry in the manual.

ACCEL RATE, M1-M4	page 21	MAIN CONT INTR	page 40
ADJ HRS HIGH	page 45	MAIN OPEN DLY	page 40
ADJ HRS LOW	page 45	MAX FWD REGEN	page 26
ADJ HRS MID	page 45	MAX FWD SPD, M1-M4	page 31
ANTI-TIEDOWN	page 41	MAX LOAD VOLTS	page 27
AUX DELAY	page 28	MAX REV REGEN	page 26
AUX TYPE	page 28	MAX REV SPD, M1-M4	page 31
BATTERY ADJUST	page 50	MIN FWD REGEN	page 27
BDI DISABLE	page 50	MIN LOAD VOLTS	page 27
BDI LIMIT SPD	page 50	MIN REV REGEN	page 27
BDI LOCKOUT	page 51	MOT WRM x10m Ω	page 44
BRAKE C/L, M1-M4	page 23	MOT HOT x10m Ω	page 44
BRAKE RATE, M1-M4	page 24	MOTOR Ω COMP	page 44
CONT DIAG	page 40	POT LOW FAULT	page 38
CREEP SPEED	page 31	PUMP METER	page 48
CURRENT RATIO	page 22	QUICK START	page 21
DECEL RATE, M1-M4	page 23	RESET VOLTS	page 49
DIS TOTL HRS	page 46	RESTRAINT, M1-M4	page 23
DIS TRAC HRS	page 46	SEQUENCING DLY	page 42
DRIVE C/L, M1-M4	page 21	SET TOTL HRS	page 45
EM BRAKE PWM	page 28	SET TRAC HRS	page 46
EMPTY VOLTS	page 49	SRO	page 42
EMR DIR INTR	page 43	SRVC TOTL	page 47
EMR REV CHECK	page 43	SRVC TOTL HRS	page 46
EMR REV C/L	page 43	SRVC TRAC	page 47
FAULT CODE	page 51	SRVC TRAC HRS	page 46
FIELD CHECK	page 40	TAPER RATE	page 25
FIELD MAP	page 39	THROTTLE DB	page 32
FIELD MAX	page 38	THROTTLE DECEL	page 23
FIELD MIN	page 38	THROTTLE MAP	page 36
FLD MAP START	page 38	THROTTLE MAX	page 34
FULL VOLTS	page 49	THROTTLE TYPE	page 32
HOURLMETER TYPE	page 48	TRAC FAULT SPD	page 47
HPD	page 41	VARIABLE BRAKE	page 25
INT BRAKE DLY	page 28	VOLTAGE	page 21
INT BRAKE RATE	page 26	WARM SPEED	page 44
LOAD COMP	page 31		

APPENDIX D

SPECIFICATIONS

Table D-1 SPECIFICATIONS: 1243^{GEN2} CONTROLLER

Nominal input voltage	24–36 V
PWM operating frequency	16 kHz
Electrical isolation to heatsink	500 V ac (minimum)
KSI input voltage (minimum)	16.8 V
KSI input current (no contactors engaged)	78 mA without programmer; 120 mA with 1311 programmer (110 mA with 1307)
Logic input voltage	>7.5 V High; <1 V Low
Logic input current	15 mA
Operating ambient temperature range	-40°C to 50°C (-40°F to 122°F)
Heatsink overtemperature cutback	85°C (185°F)
Heatsink undertemperature cutback	-25°C (-13°F)
Overvoltage protection	24V models: cutback at approx. 30V, cutback at ≈34V 36V models: cutback at approx. 45V, cutback at ≈49V
Undervoltage protection	24V models: cutback at approx. 17V, cutback at ≈13V 36V models: cutback at approx. 25V, cutback at ≈21V
Package environmental rating	IP53
Weight	1.45 kg (3.2 lb)
Dimensions (L×W×H)	198 × 114 × 70 mm (7.8" × 4.5" × 2.8")
Regulatory compliance	Safety, applicable portions: EN 1175-1:1998 EMC and EMI: EN 12895:2000 UL Recognized Component, UL File AU1841

MODEL NUMBER*	NOMINAL BATTERY VOLTAGE (volts)	DRIVE CURRENT LIMIT (amps)	ARMATURE		FIELD		BRAKING CURRENT LIMIT (amps)
			2 MIN RATING (amps)	1 HOUR RATING (amps)	2 MIN RATING (amps)	1 HOUR RATING (amps)	
1243-24XX	24	350	350	120	35	20	350
1243-42XX	24–36	200	200	80	25/35†	15/20	200
1243-43XX	24–36	300	300	100	25/35†	15/20	300

* The last two digits of 1243^{GEN2} model numbers are 20 or higher:

1243-2401, 1243-4202, and 1243-4301 are 1243 controllers,

1243-2420, 1243-4221, and 1243-4320 are 1243^{GEN2} controllers.

† The 1243-42XX and -43XX models are available as 25 amp or 35 amp models.